

+

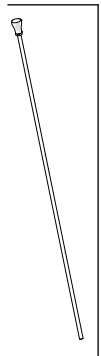

Not included / Non incluso / Non inclus / Nie zawarty / No incluido / Não incluido



C

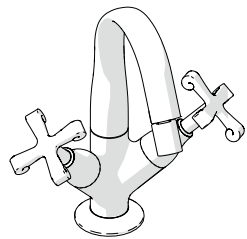

A



D

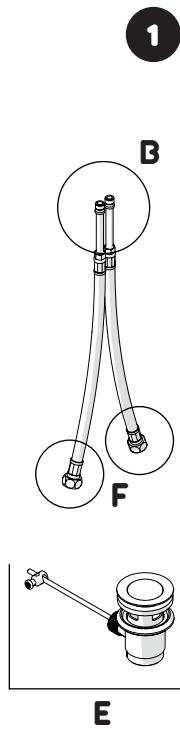

1

2

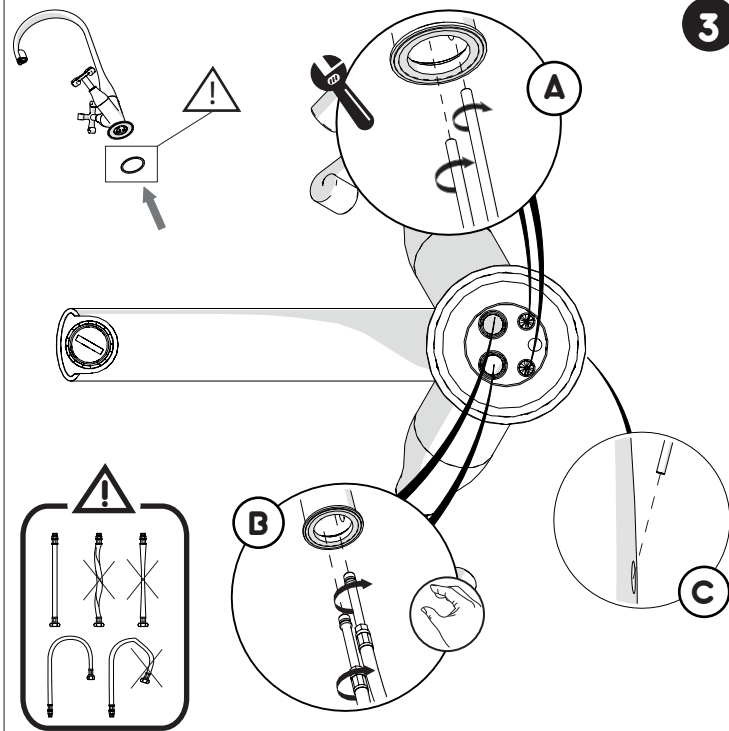
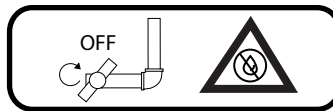
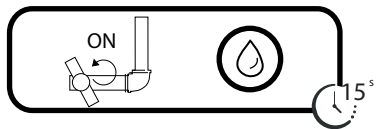

3

4

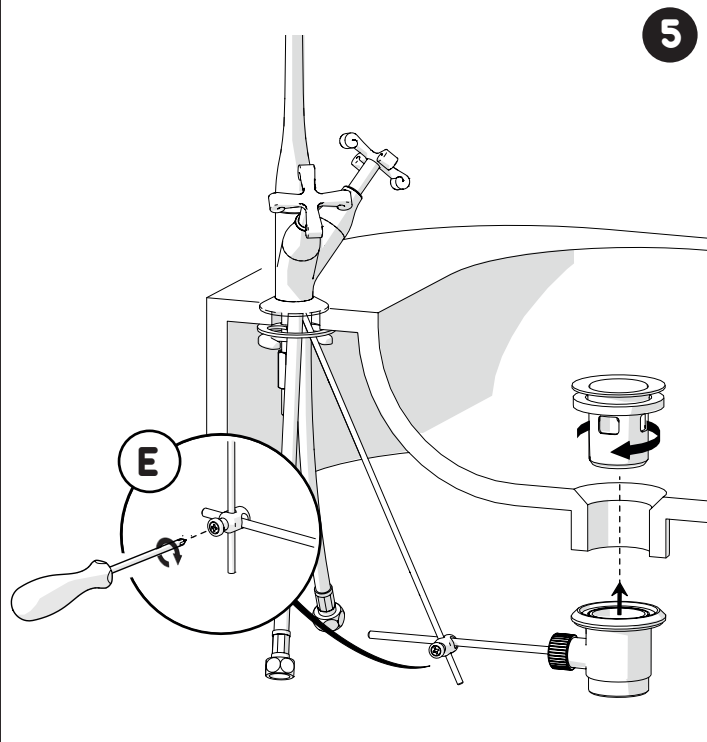
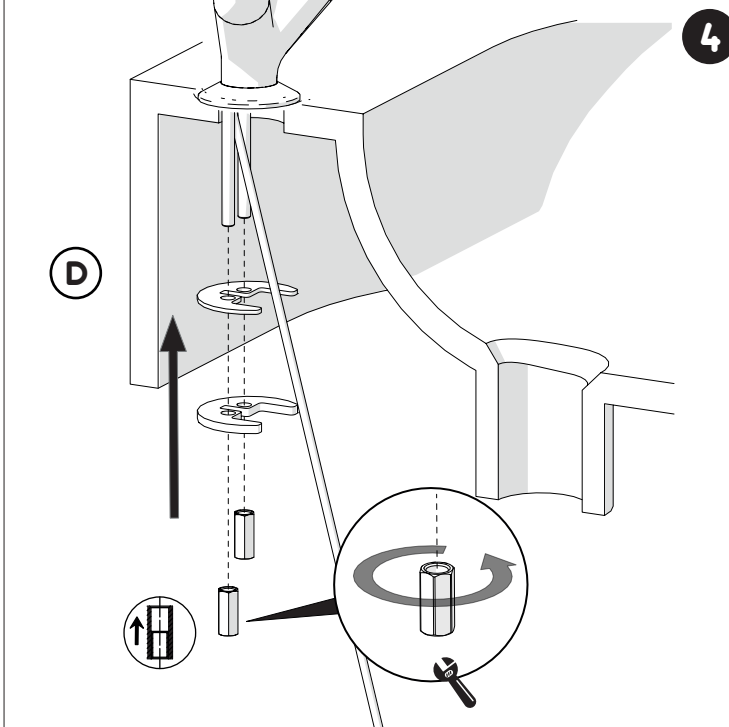

5

6

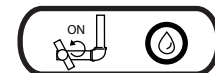
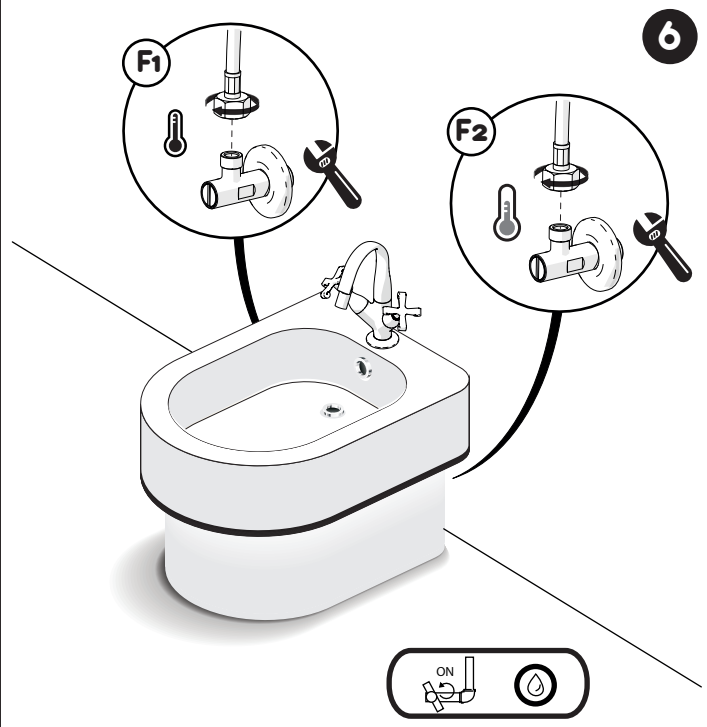

7

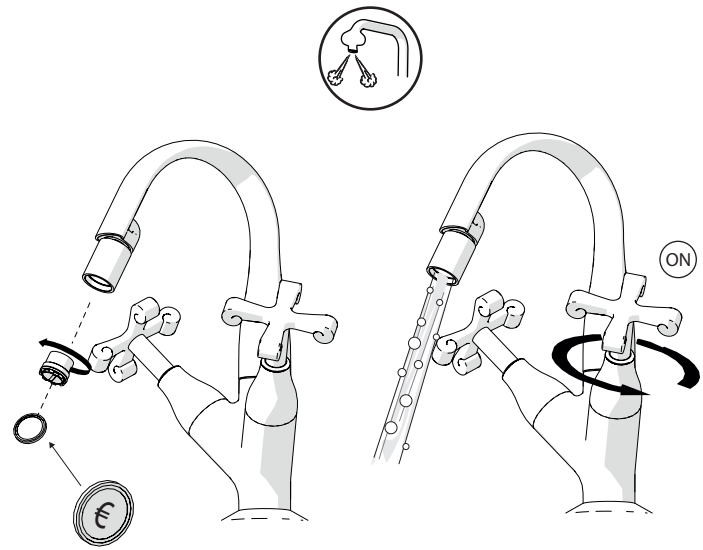

9

CLEANING

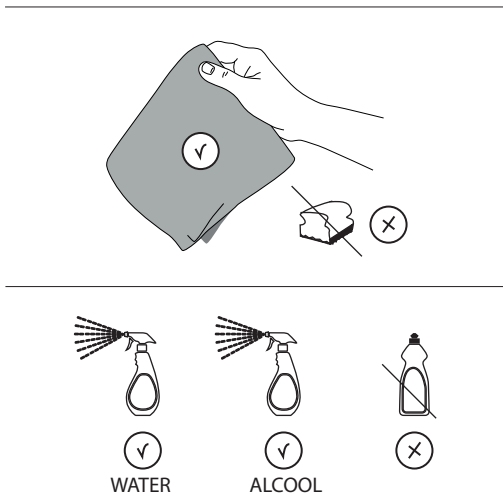

**NOBILIS®**  
The Best Technology for Water

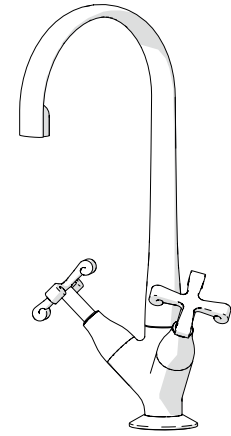

CP219/1



www.grupponobili.it

IISTRCP219/1--STD

REV1.06/2013

8

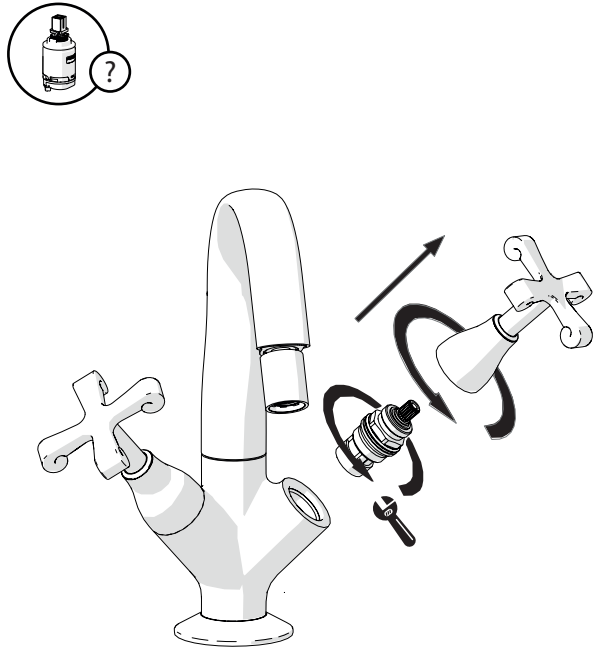

**NOBILIS®**  
The Best Technology for Water

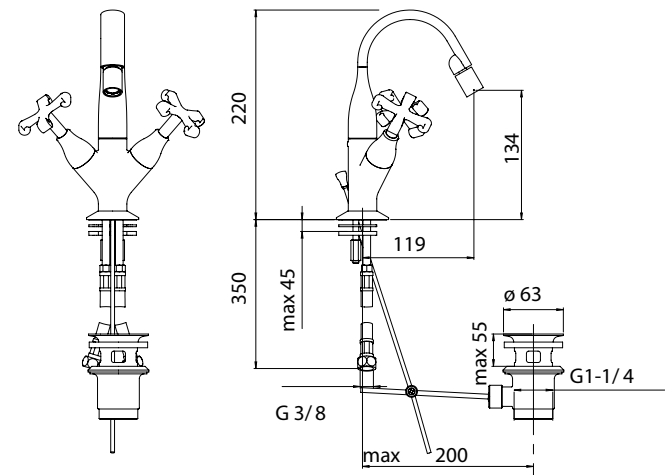

P	P bar	MAX 10	MIN. 0,5	5	T	T °C	MAX 90	MIN. 45
---	-------	--------	----------	---	---	------	--------	---------