

Not included / Non incluso / Non Inclus / Nie zawarty/ No incluido / Nao incluido

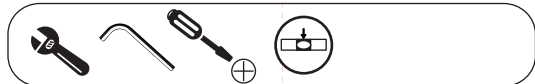

1

A

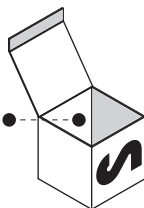
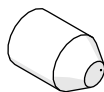

B

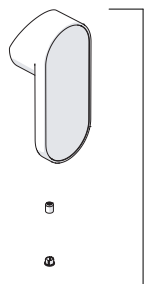
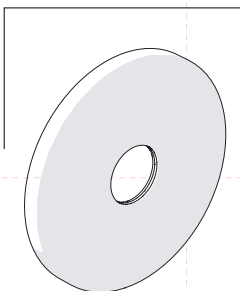

C

GUARNIZIONE DI RICAMBIO  
SPARE PART GASKET

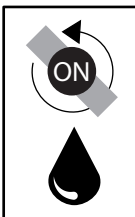
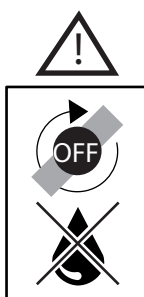
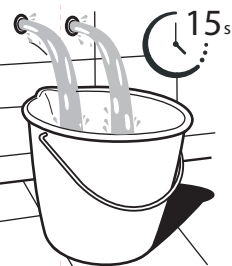
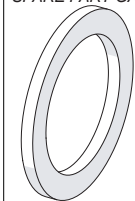

A

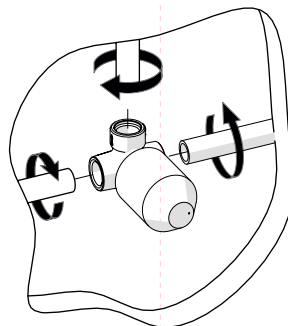

2

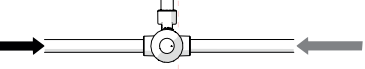

TEST PER I TUBI  
PRIMA DELLA CARTUCCIA (A)  
TEST FOR THE PIPES  
BEFORE CARTRIDGE (A)

ATTENZIONE!  
Durante il test la cartuccia deve essere  
in posizione "chiusa"!

ATTENTION!  
During test cartridge must be  
placed in "CLOSED POSITION"



TEST

TEST PER I TUBI  
DOPO LA CARTUCCIA (B)

TEST FOR THE PIPES  
AFTER CARTRIDGE (B)

ATTENZIONE!  
Secondo la norma europea EN817, in caso  
di test per i tubi dopo la cartuccia, la pressione  
deve essere a 4 bar per 1 minuto e la cartuccia  
in posizione "aperta"

ATTENTION!  
As per european rule EN817, in  
case of test for the pipes after  
cartridge, the pressure  
must be within 4 bar for 1 minute and the  
cartridge in "open position"

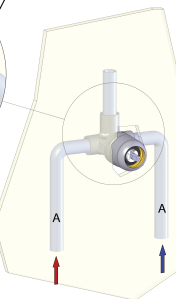
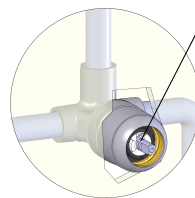

3

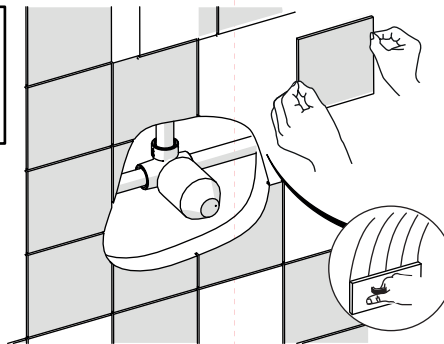

4

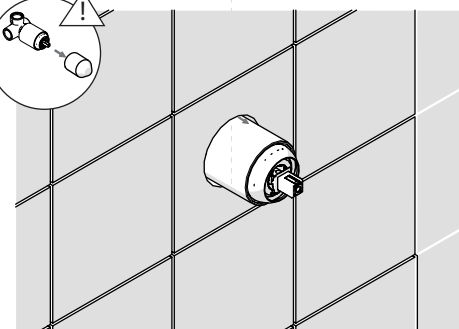
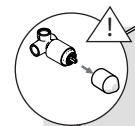

5

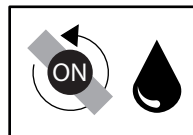
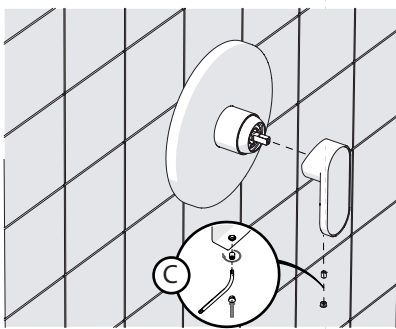
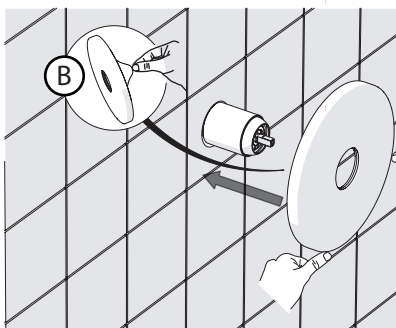



Dispositivo limitatore "dinamico"  
della portata d'acqua "50%"  
"Dynamic" flow rate restrictor "50%"

6

CLOSE ON 50% ON 100%



Posizione di chiusura  
Closed position

Posizione di risparmio  
acqua "50% portata"  
Position of water  
saving "50% capacity"

Posizione di apertura  
totale 100% portata  
100% Fully open flow

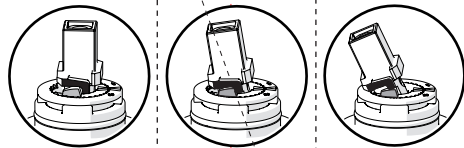

Per limitare la temperatura estrarre il limitatore  
e riposizionarlo nella posizione che si desidera  
Extract the limiter and put it in correct  
position to limit temperature

8

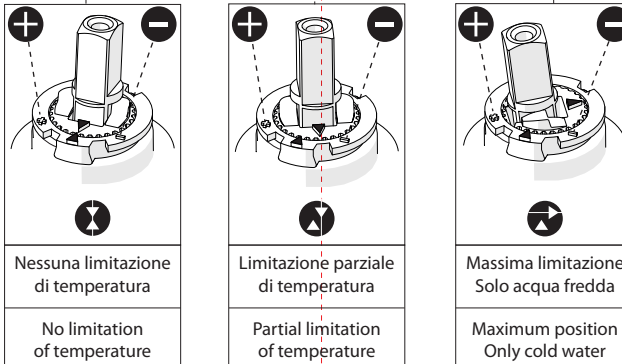
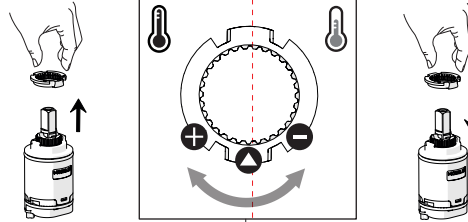

7

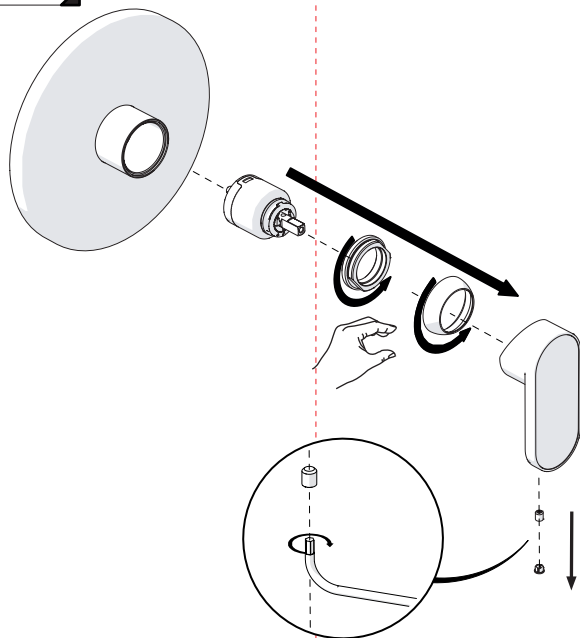

9

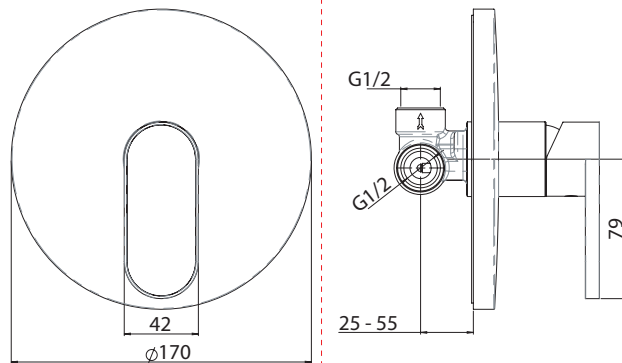

**NOBILIS**<sup>®</sup>  
The Best Technology for Water

DRESS

DS106108

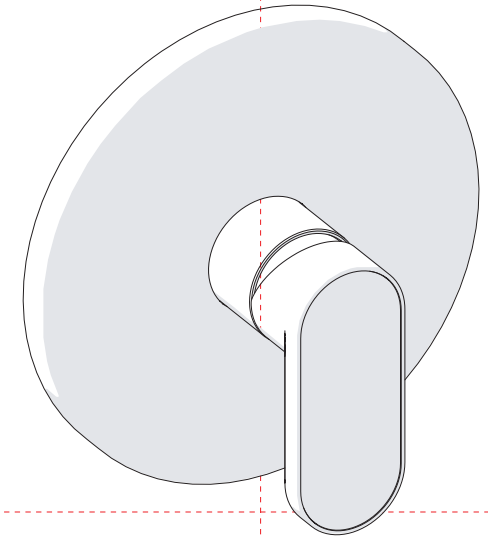

www.grupponobili.it

PRIMA DI INIZIARE / BEFORE STARTING

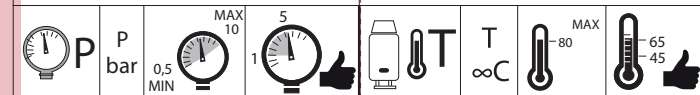

PULIZIA / CLEANING

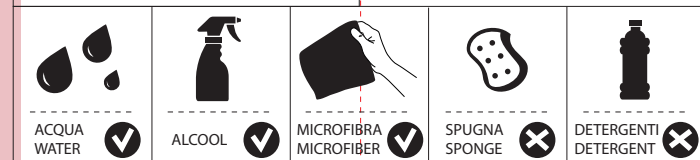

IISTRDS106108#---STD



REV0.03/2016