

Not included / Non incluso / Non Inclus / Nie zawarty/ No incluido / Nao incluido

1



A1



A2

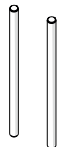

D1



D2



DISPONIBILE SOLO PER ALCUNE SERIE  
AVAILABLE ONLY FOR SOME SERIES

ANELLO DI GUIDA  
GUIDE RING



119/1



C2

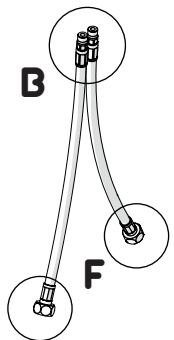

119/1

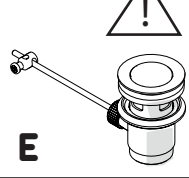

C

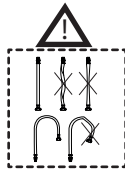
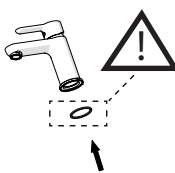
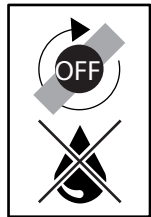
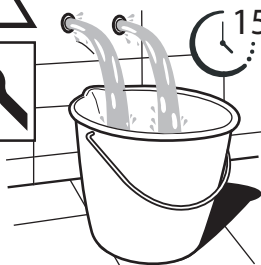
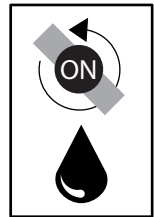

2

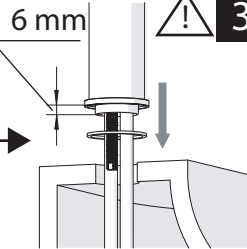
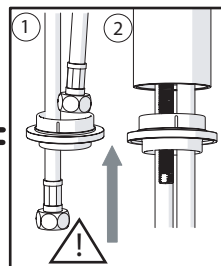
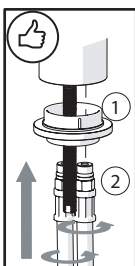
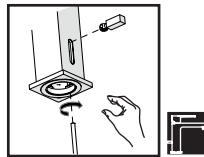
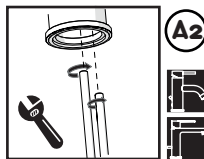
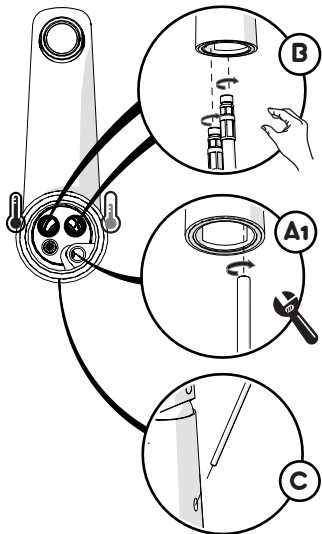

3

D1

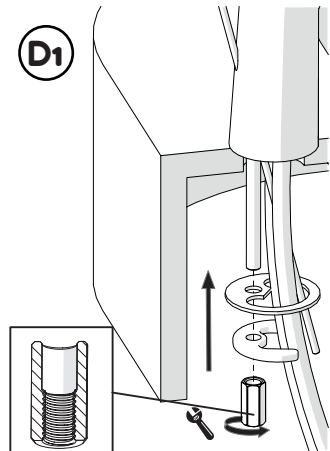

D2

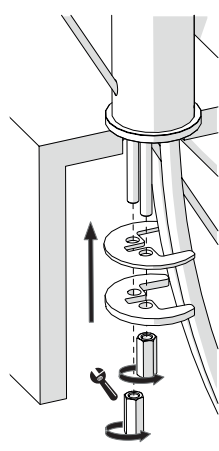

4

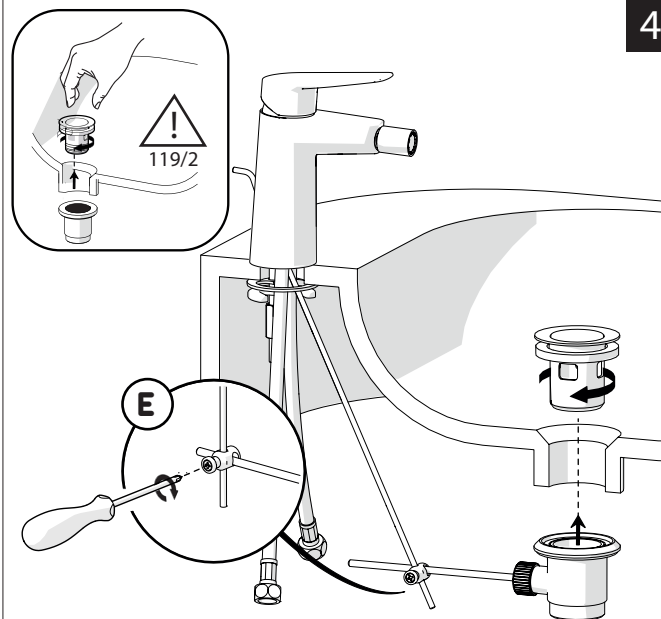

5

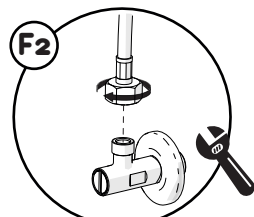
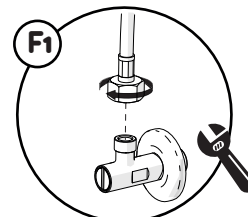

ROSSO/CALDO  
RED/HOT

BLU/FREDDO  
BLUE/COLD

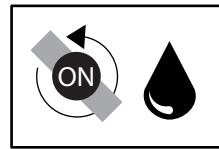



Dispositivo limitatore "dinamico" della portata d'acqua "50%"  
"Dinamic" flow rate restrictor "50%"



CLOSE ON 50% ON 100%

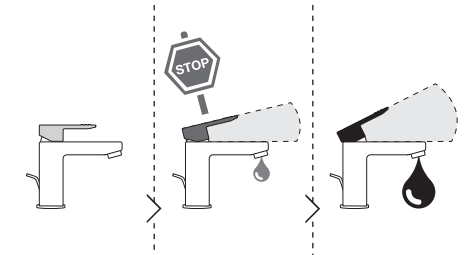

Posizione di chiusura Posizione di risparmio acqua "50% portata" Posizione di apertura totale 100% portata

Closed position Position of water saving "50% capacity" 100% Fully open flow

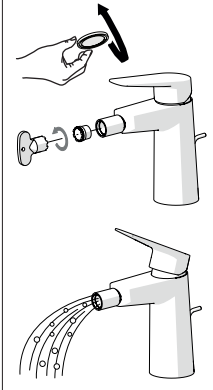
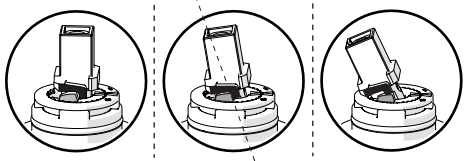

ESEMPI DISEGNO TECNICO  
EXAMPLES OF TECHNICAL DRAWING

6

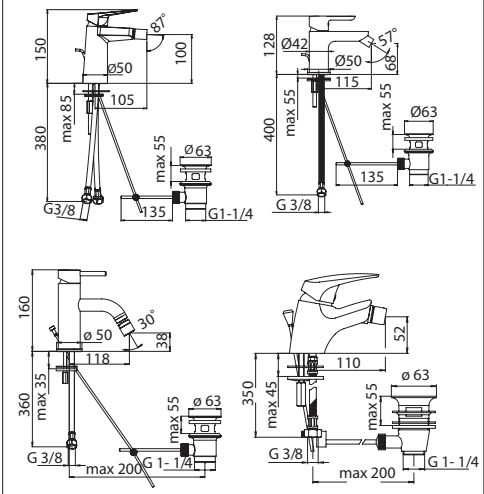

7

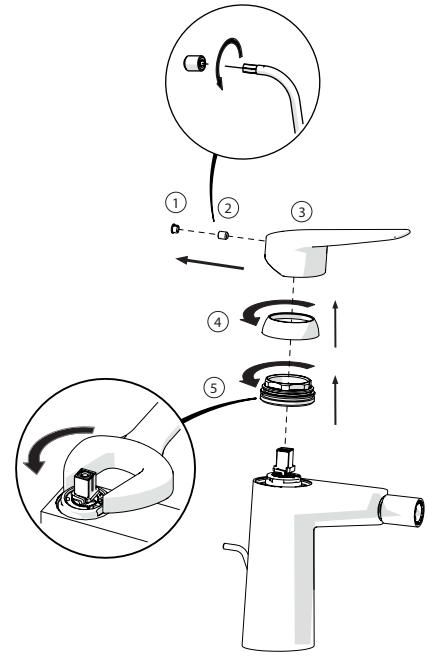
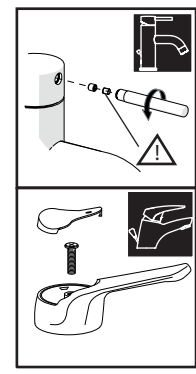

8

Per limitare la temperatura estrarre il limitatore e riposizionarlo nella posizione che si desidera

Extract the limiter and put it in correct position to limit temperature

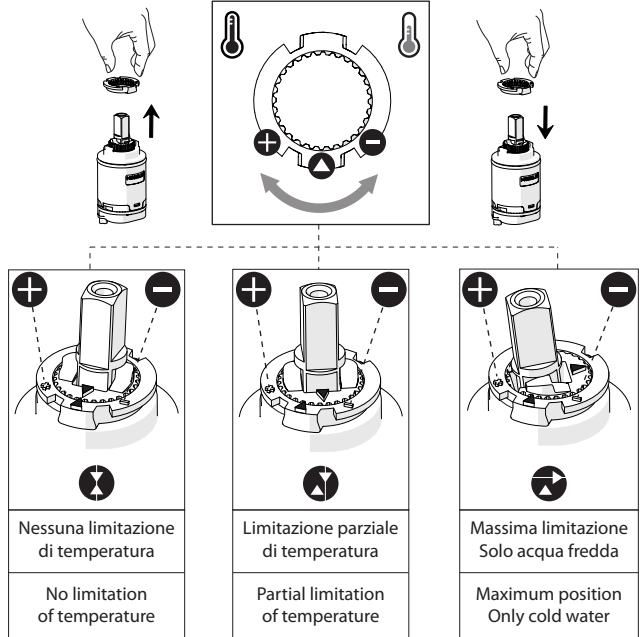

NOBILI S

119

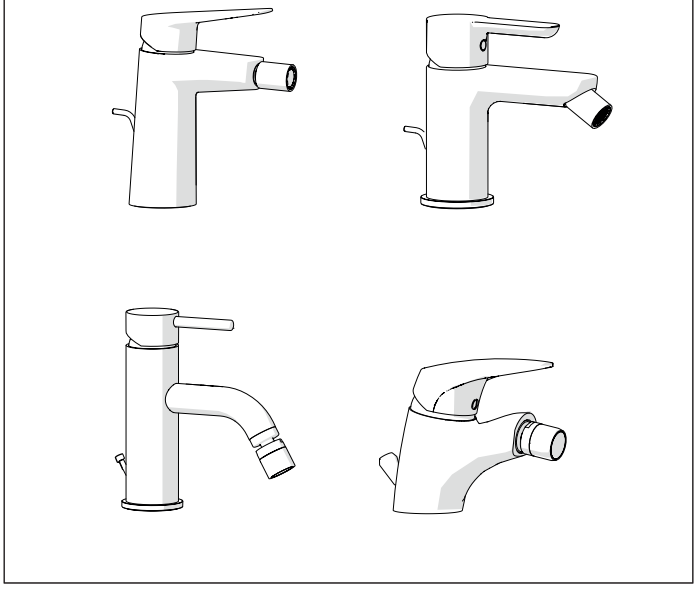

www.nobili.it

PRIMA DI INIZIARE / BEFORE STARTING

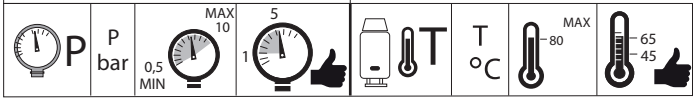

PULIZIA / CLEANING



IISTR00119#---STD



REV2.10/2015