

Not included / Non incluso / Non Inclus / Nie zawarty / No incluido / Nao incluido

1

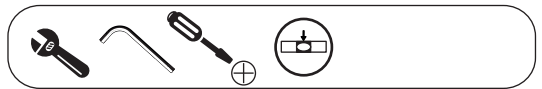

A1

A2

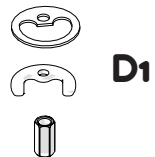

D1



D2

DISPONIBILE SOLO PER ALCUNE SERIE  
AVAILABLE ONLY FOR SOME SERIES

ANELLO DI GUIDA  
GUIDE RING

118/1

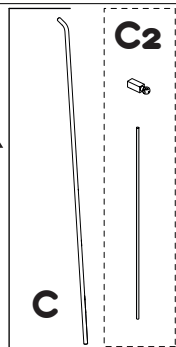

C2

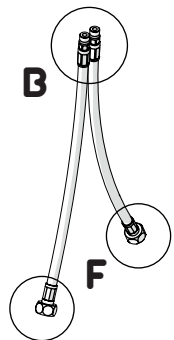

B

F

118/1

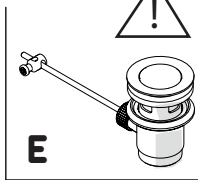

E

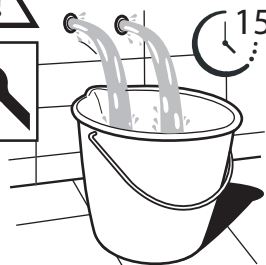
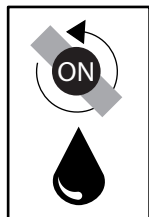

15s

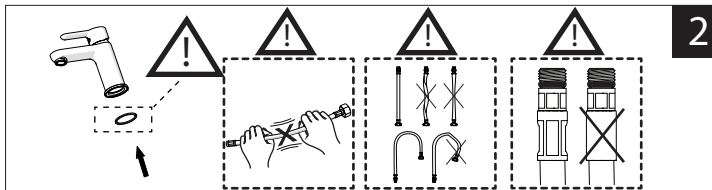
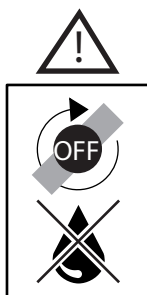

2

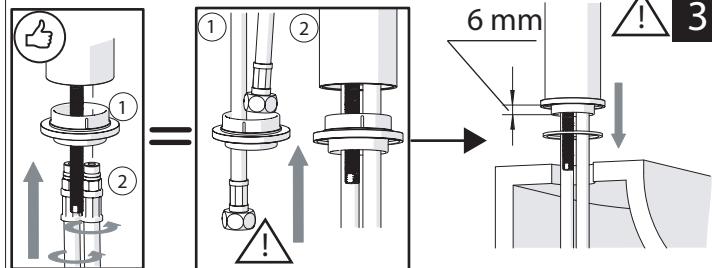
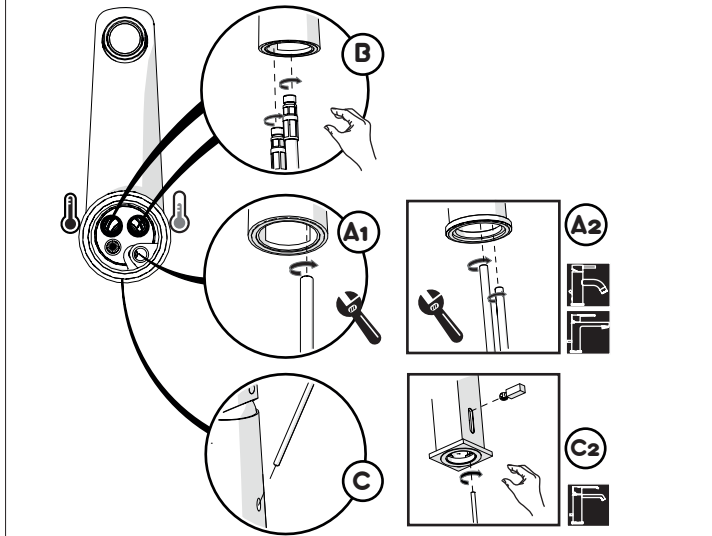

3

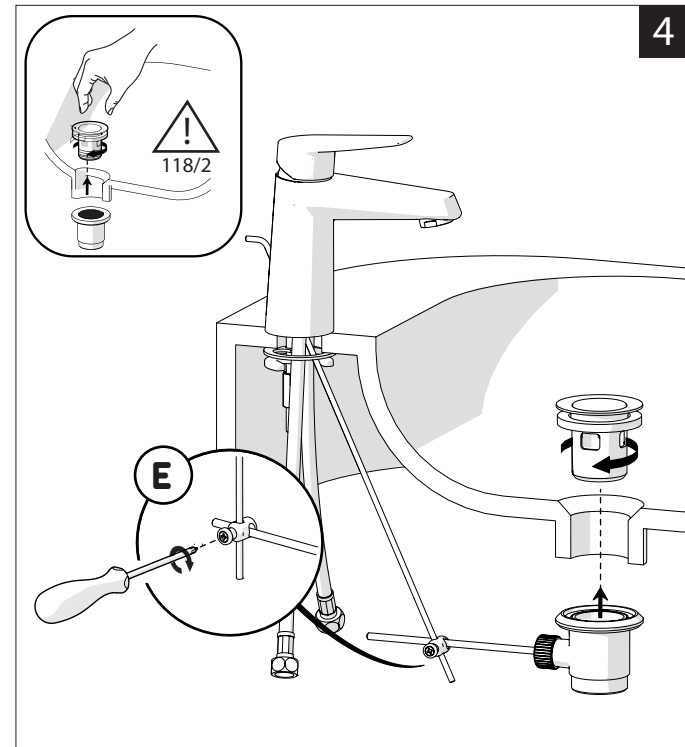
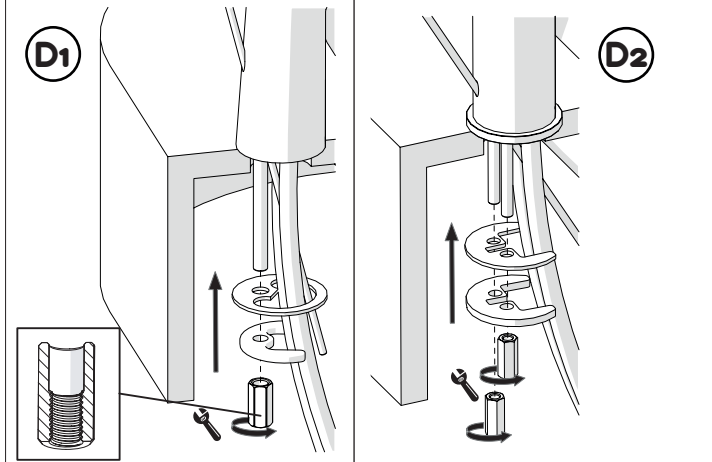

4

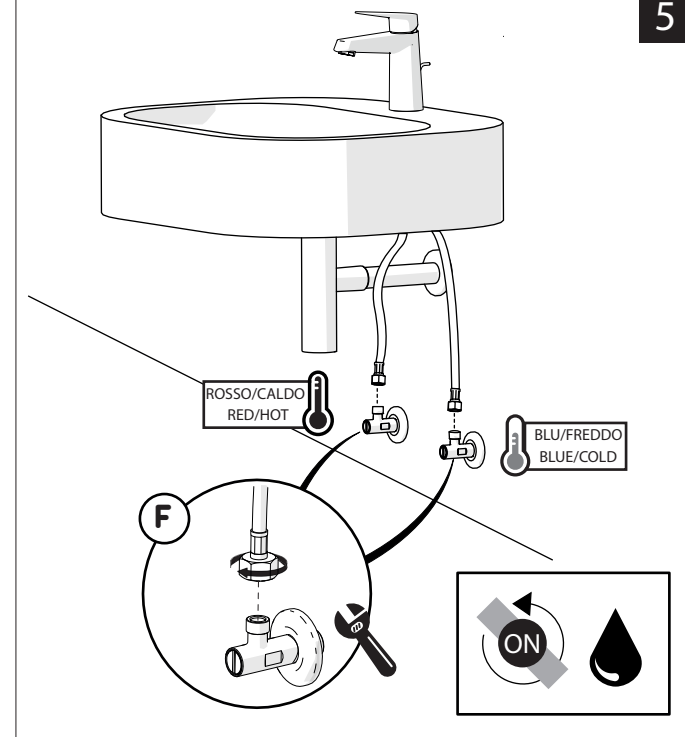

5

ROSSO/CALDO  
RED/HOT

BLU/FREDDO  
BLUE/COLD

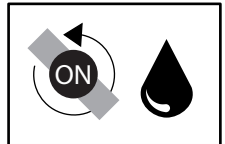



Dispositivo limitatore "dinamico" della portata d'acqua "50%"

"Dinamic" flow rate restrictor "50%"



VARIE POSSIBILITA' PER SMONTARE L'AERATORE  
SEVERAL OPTIOS FOR REMOVING AERATOR



ESEMPI DISEGNO TECNICO  
EXAMPLES OF TECHNICAL DRAWING

6

CLOSE ON 50% ON 100%

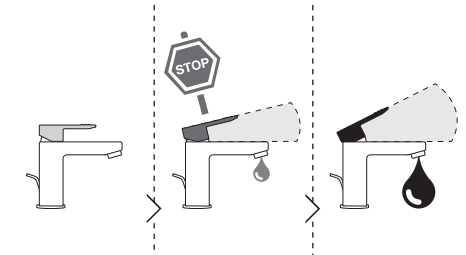

Posizione di chiusura  
Closed position

Posizione di risparmio acqua "50% portata"  
Position of water saving "50% capacity"

Posizione di apertura totale 100% portata  
100% Fully open flow

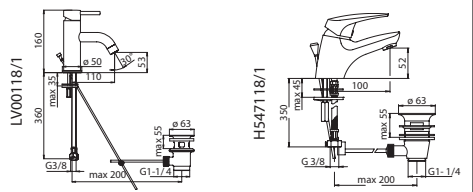
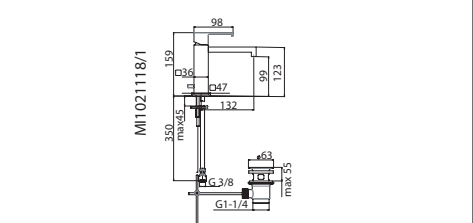
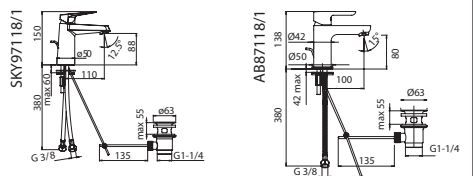
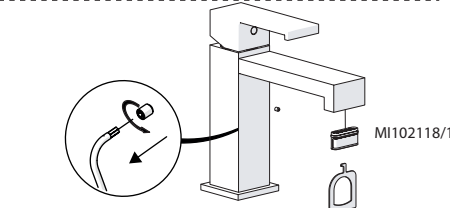
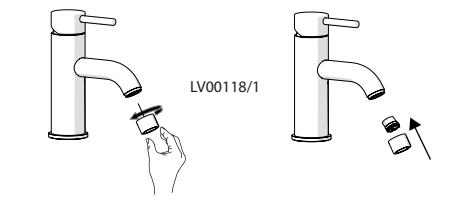
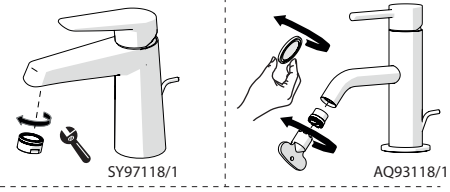
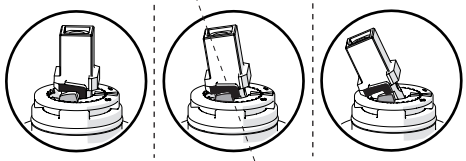

NOBILIS

118



www.nobili.it



7

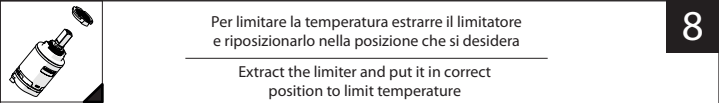
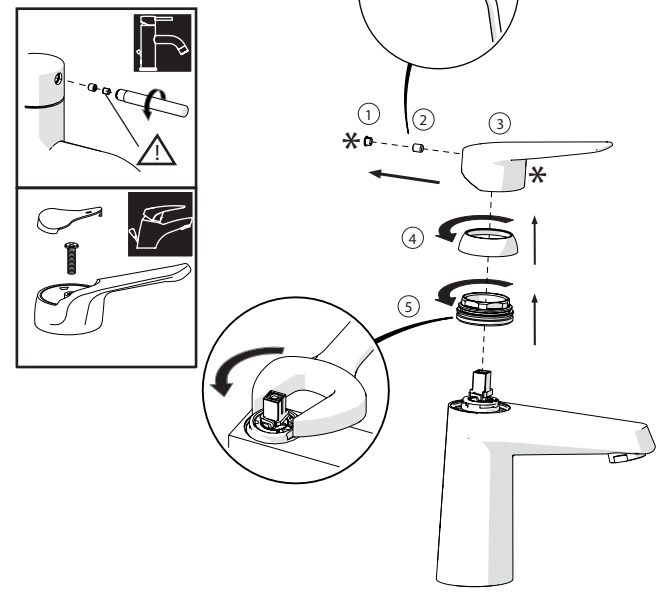

8

Per limitare la temperatura estrarre il limitatore e riposizionarlo nella posizione che si desidera

Extract the limiter and put it in correct position to limit temperature

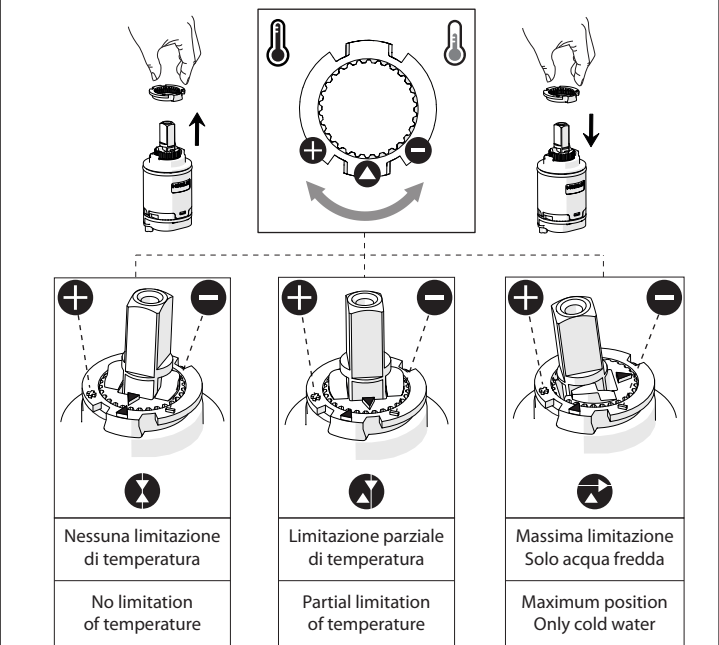

PRIMA DI INIZIARE / BEFORE STARTING

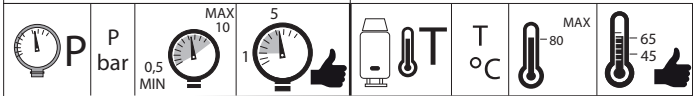

PULIZIA / CLEANING



IISTR00118#---STD



REV4.07/2020