

Not included / Non incluso / Non Inclus / Nie zawarty / No incluido / Nao incluido

1

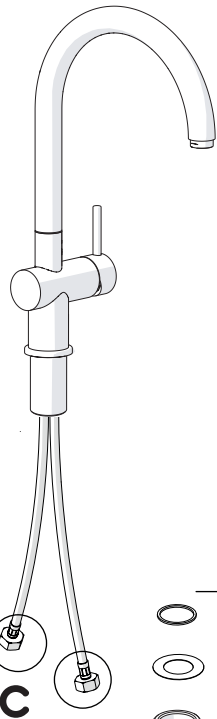

opzionale
optional

B

C

A

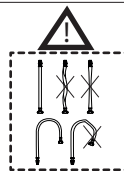
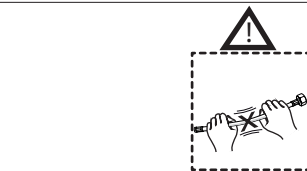
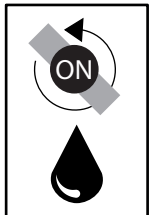
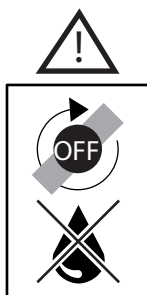
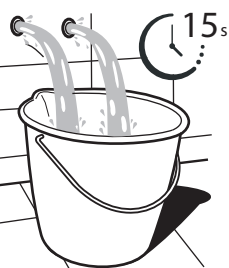

2

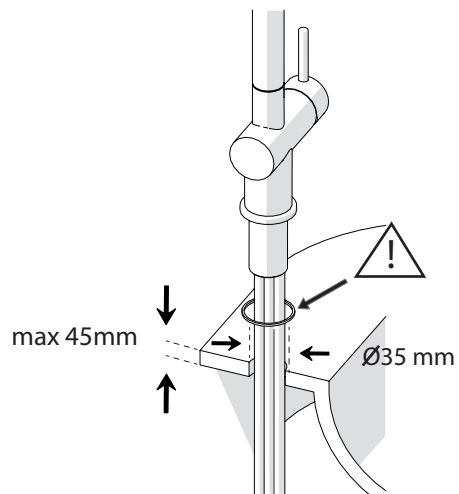

3

A

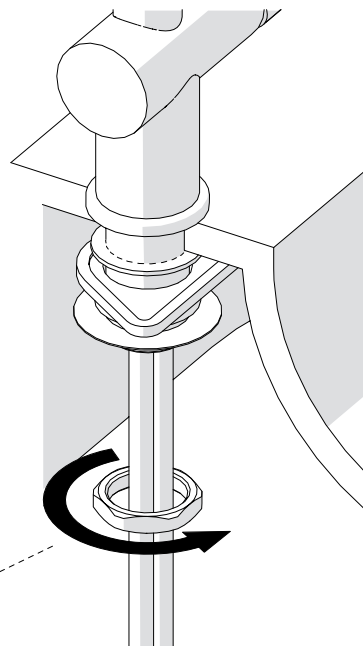

40 mm

4

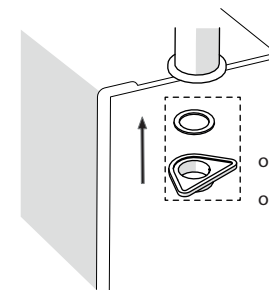
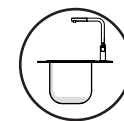

B

opzionale per lavelli sottili
optional for thin sinks

5

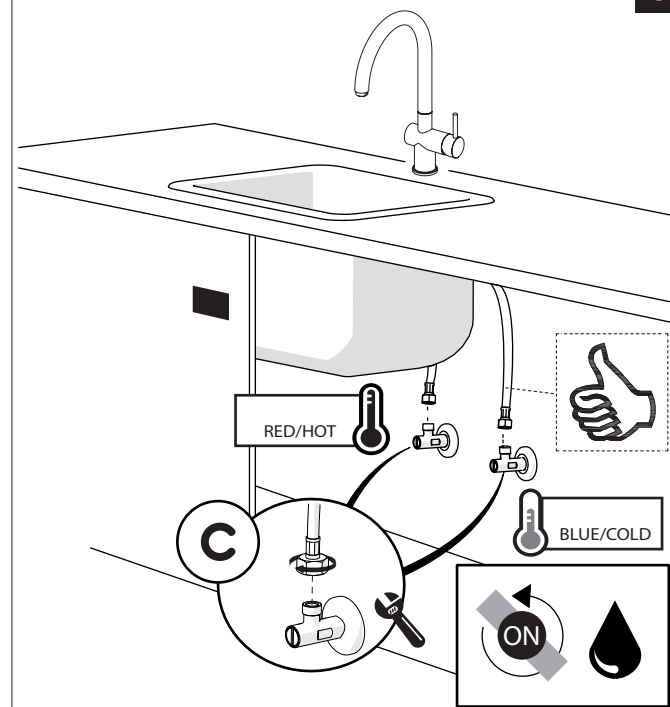

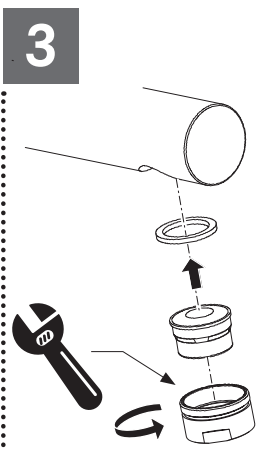
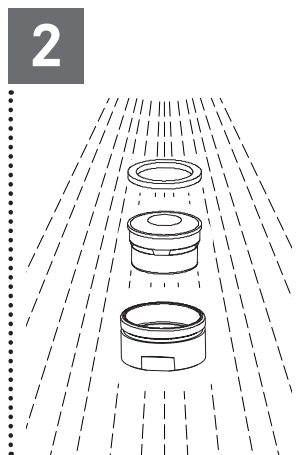
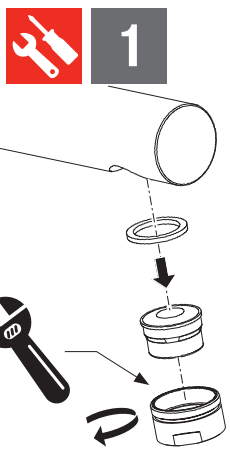
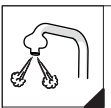

CLEANING

6

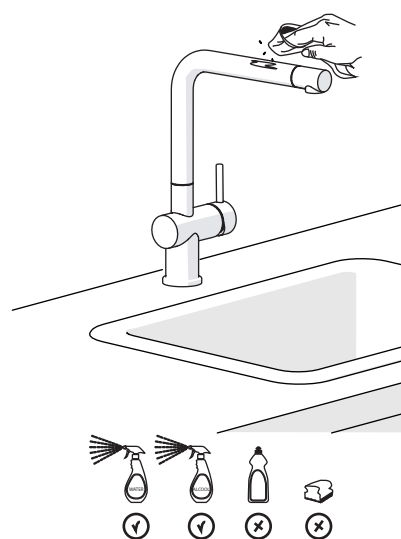

NOBILIS



7

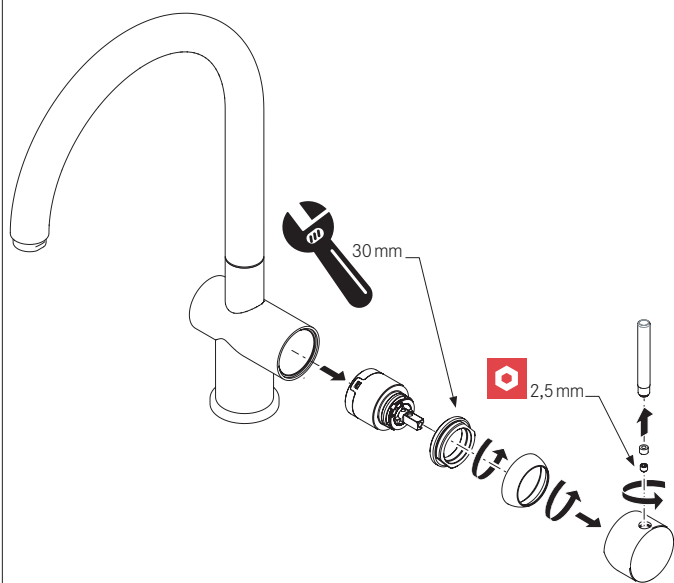

8

Per limitare la temperatura estrarre il limitatore e riposizionarlo nella posizione che si desidera

Extract the limiter and put it in correct position to limit temperature

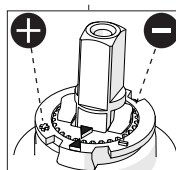
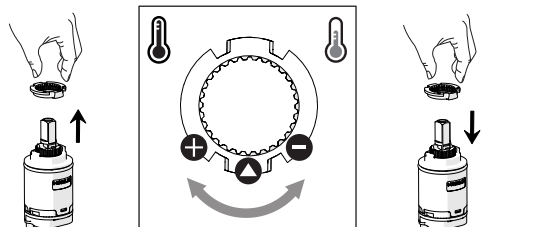

Nessuna limitazione di temperatura

No limitation of temperature

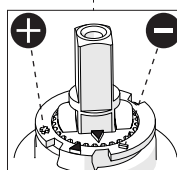

Limitazione parziale di temperatura

Partial limitation of temperature

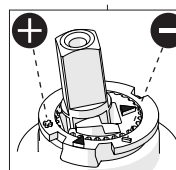

Massima limitazione Solo acqua fredda

Maximum position Only cold water



www.grupponobili.it

PRIMA DI INIZIARE / BEFORE STARTING



PULIZIA / CLEANING

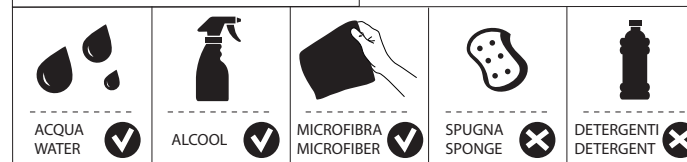

IISTRBR00213#---STD



REV0.09/2019