

Not included / Non incluso / Non Inclus / Nie zawarty/ No incluido / Nao incluido

1

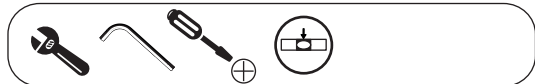

B1

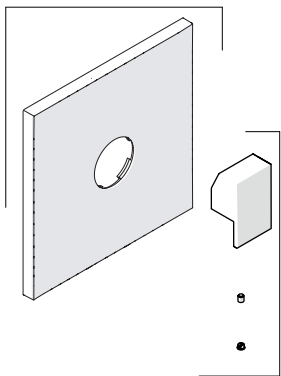

B2

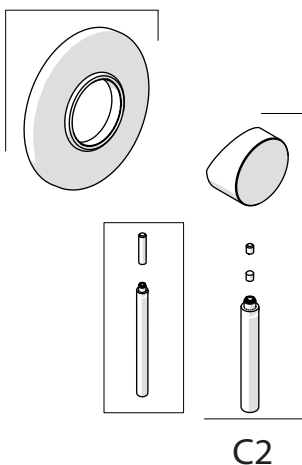

C1

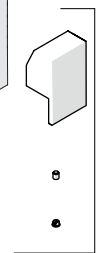

2

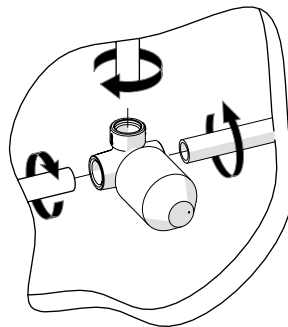

(A)

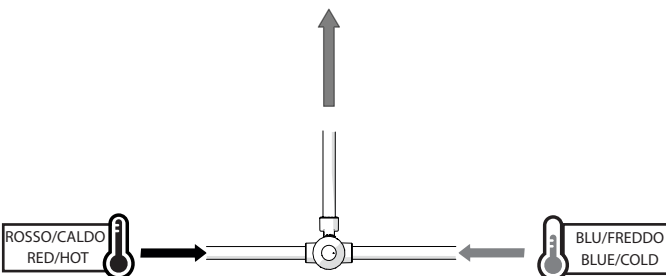

TEST PER I TUBI PRIMA DELLA CARTUCCIA (A)  
TEST FOR THE PIPES BEFORE CARTRIDGE (A)

ATTENZIONE!  
Durante il test la cartuccia deve essere in posizione "chiusa"!

ATTENTION!  
During test cartridge must be placed in "CLOSED POSITION"

3



TEST PER I TUBI DOPO LA CARTUCCIA (B)  
TEST FOR THE PIPES AFTER CARTRIDGE (B)

ATTENZIONE!  
Secondo la norma europea EN817, in caso di test per i tubi dopo la cartuccia, la pressione deve essere a 4 bar per 1 minuto e la cartuccia in posizione "aperta"

ATTENTION!  
As per european rule EN817, in case of test for the pipes after cartridge, the pressure must be within 4 bar for 1 minute and the cartridge in "open position"

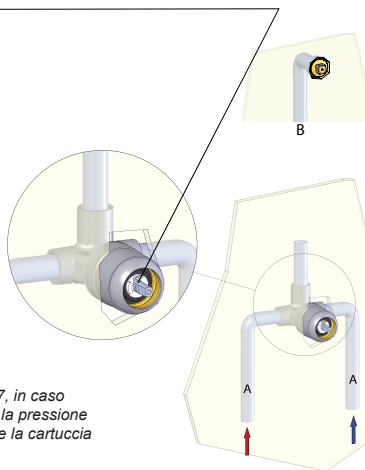

4

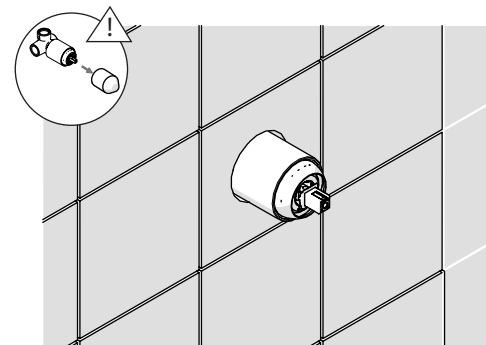
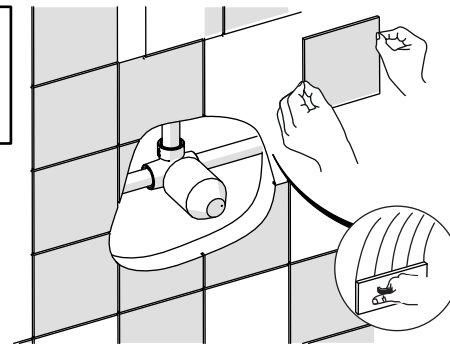

5

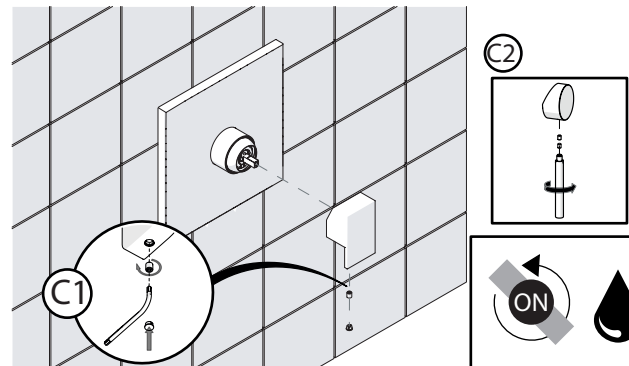
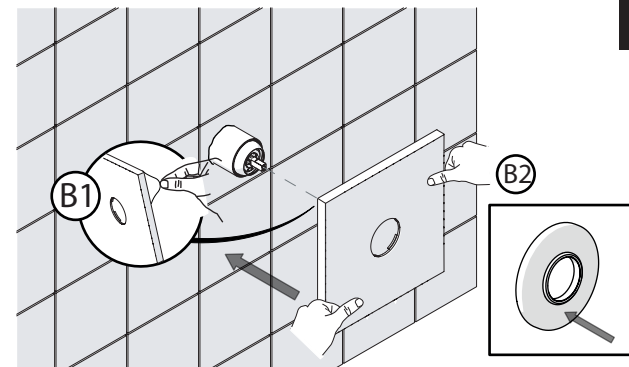



Dispositivo limitatore "dinamico" della portata d'acqua "50%"  
"Dynamic" flow rate restrictor "50%"

6

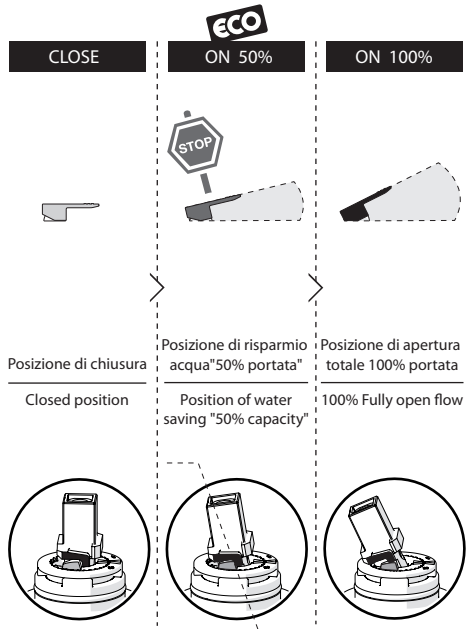

Per limitare la temperatura estrarre il limitatore e riposizionarlo nella posizione che si desidera  
Extract the limiter and put it in correct position to limit temperature

8

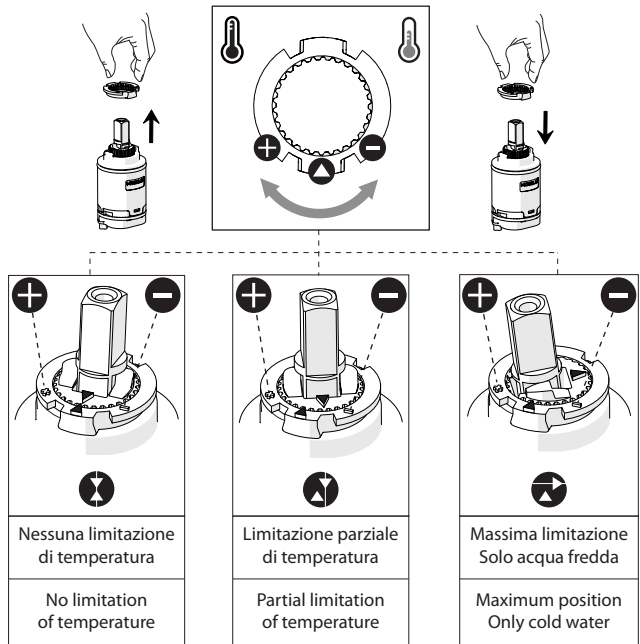

NOBILIS

108

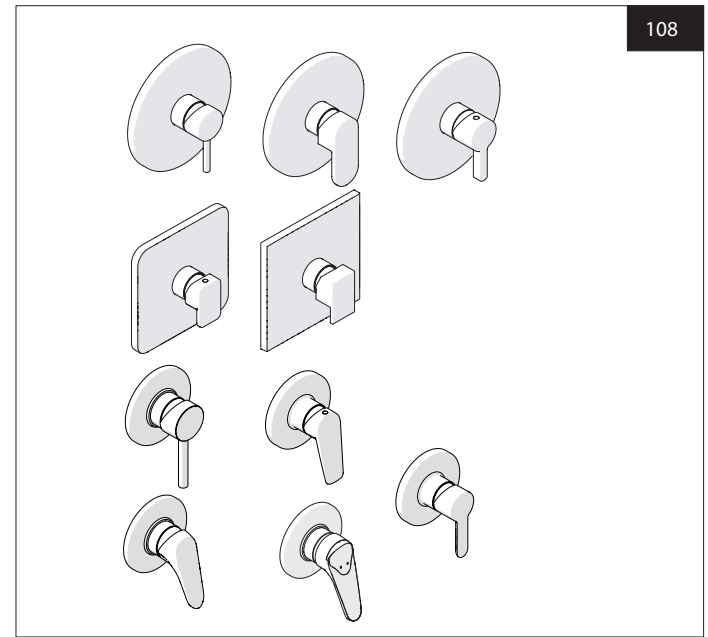

www.nobilis.it

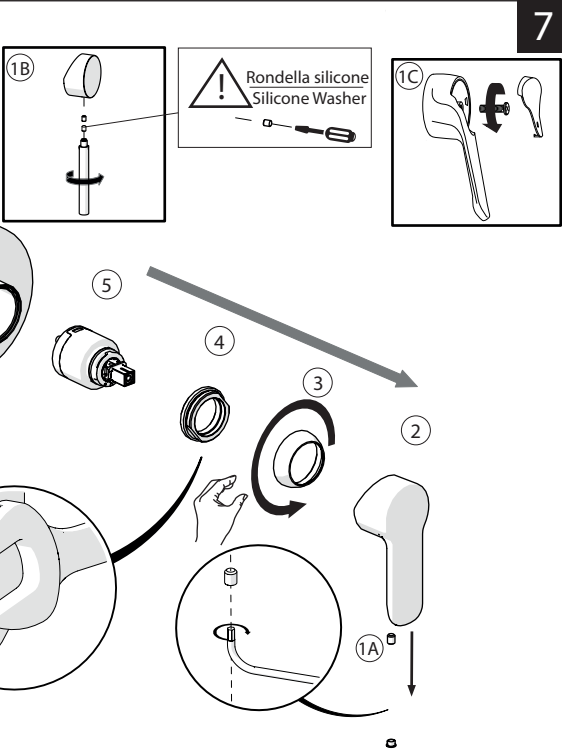

7



ESEMPI DISEGNO TECNICO  
EXAMPLES OF TECHNICAL DRAWING

9

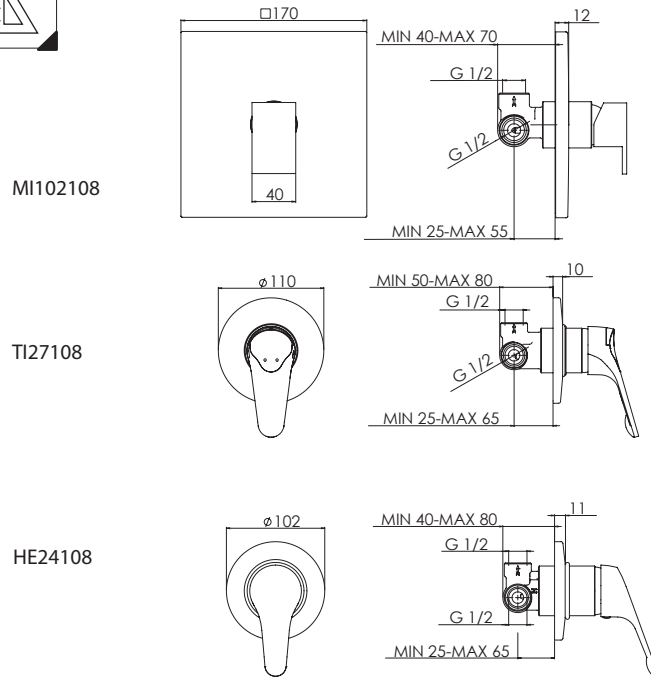

PRIMA DI INIZIARE / BEFORE STARTING

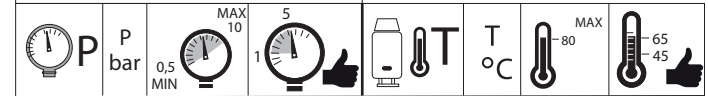

PULIZIA / CLEANING



IISTR00108#---STD



REV4.01/2018