

Not included / Non incluso / Non Inclus / Nie zawarty/ No incluido / Nao incluido

1

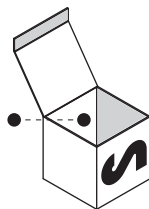

A

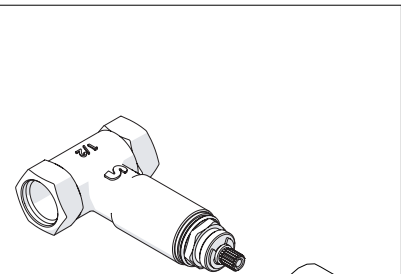

B

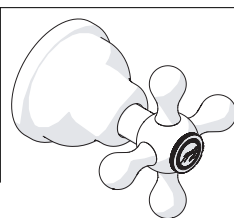

GRC5008/1

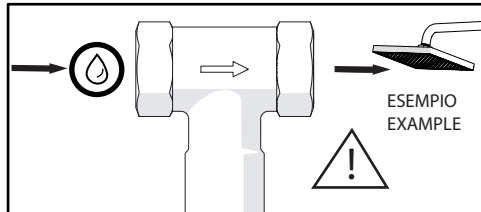
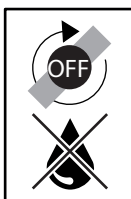
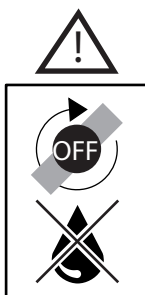
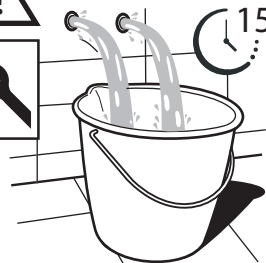
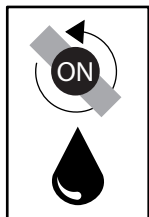

2

A

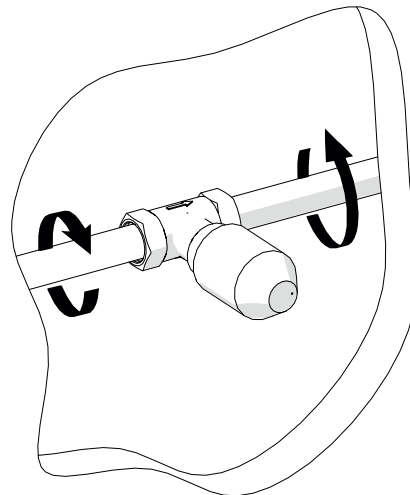

3

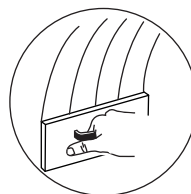
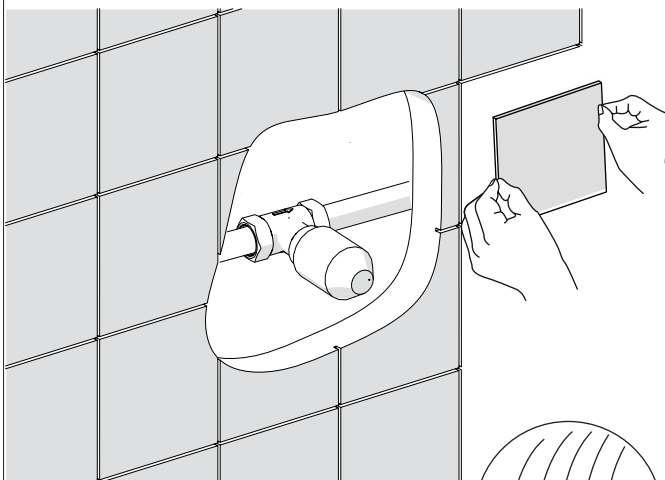

PIASTRELLA
TILE

4

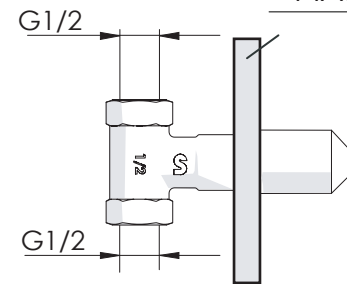

min30-max45

min30-max57 solo/only CP208/1 - CP208/1T3

LR116208/1- LR116208/1T1

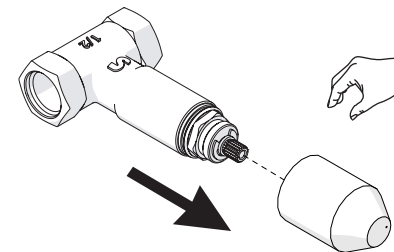

5

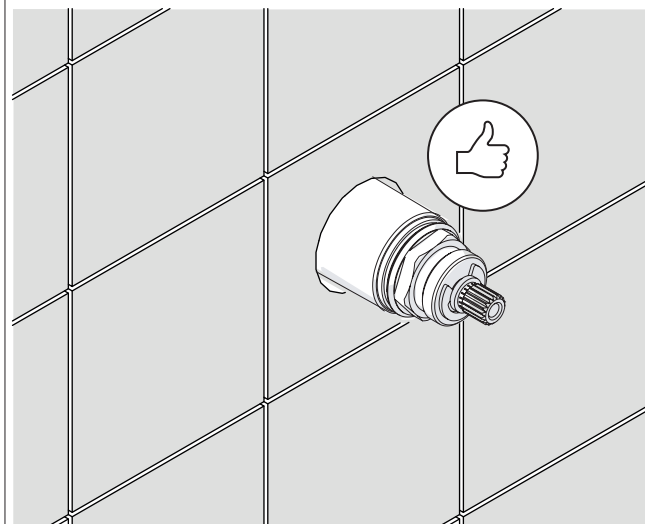

- 008/1
- 008/3
- 208/1

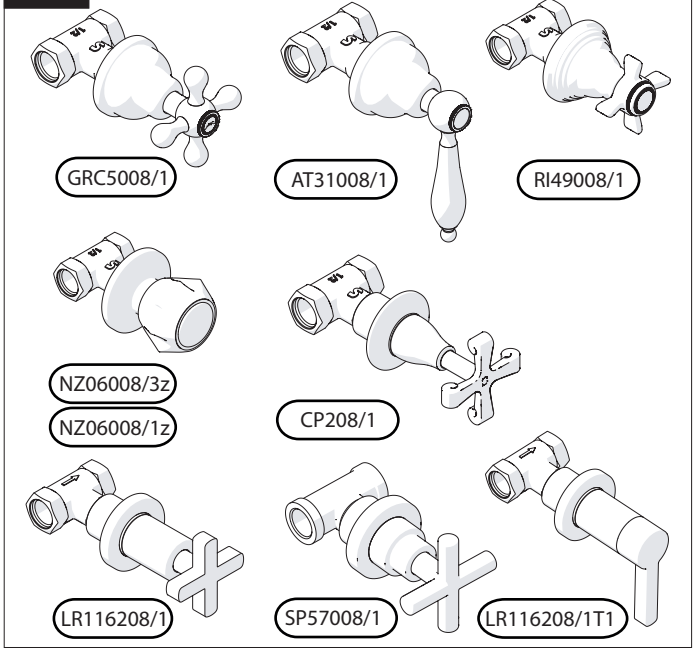

www.grupponobili.it

PRIMA DI INIZIARE / BEFORE STARTING

	P bar		MAX 10 MIN 0.5		MAX 5 MIN 1		T °C		MAX 80		MAX 65 MIN 45
--	-----------------	--	-------------------	--	----------------	--	----------------	--	--------	--	------------------

PULIZIA / CLEANING

	ACQUA WATER		ALCOOL		MICROFIBRA MICROFIBER		SPUGNA SPONGE		DETERGENTI DETERGENT
✓	✓	✓	✓	✓	✓	✗	✗	✗	✗

6

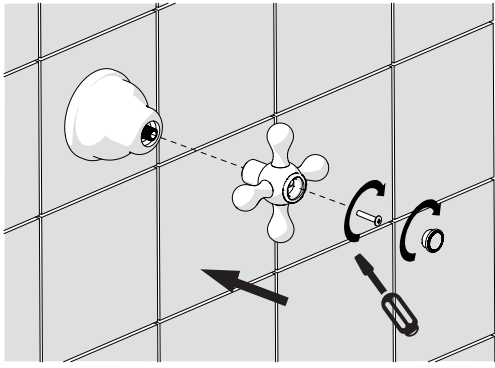
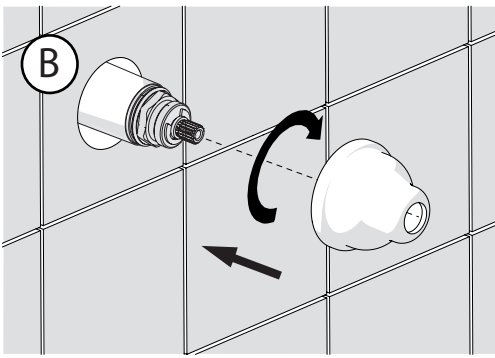

7

B

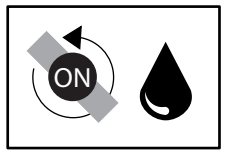
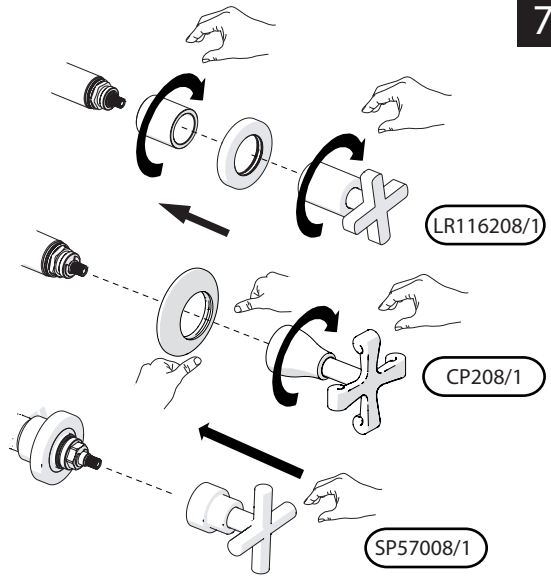

8

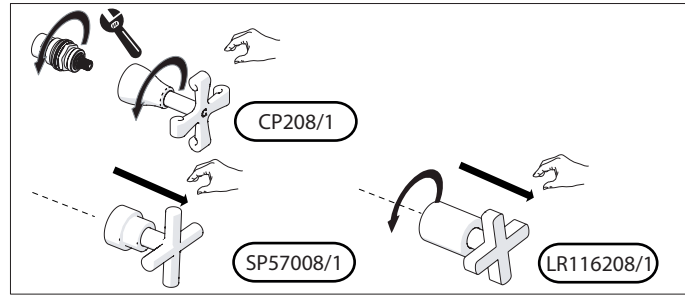
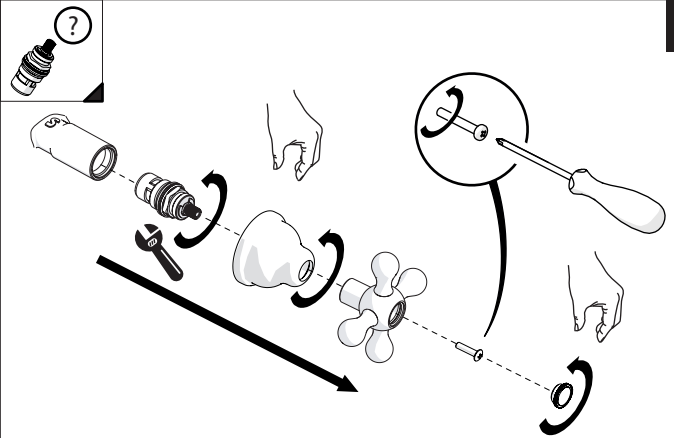

9

ESEMPI DISEGNO TECNICO
EXAMPLES OF TECHNICAL DRAWING

