

-50%

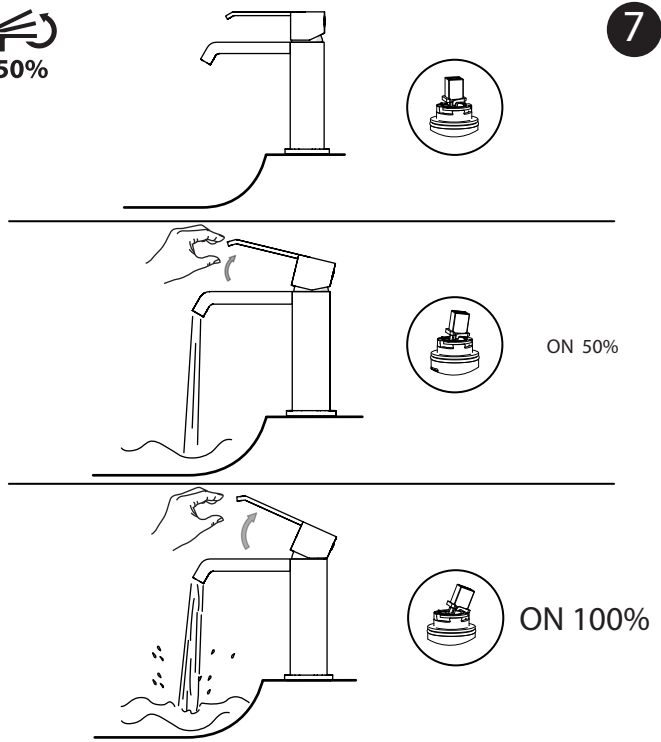

7

ON 50%

ON 100%



Per limitare la temperatura estrarre il limitatore e riposizionarlo nella posizione che si desidera

Extract the limiter and put it in correct position to limit temperature

9

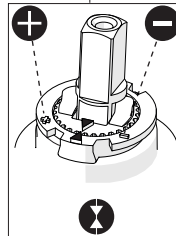
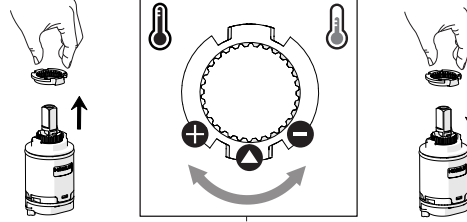

Nessuna limitazione di temperatura

No limitation of temperature

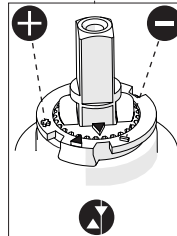

Limitazione parziale di temperatura

Partial limitation of temperature

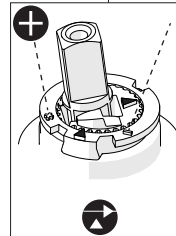

Massima limitazione Solo acqua fredda

Maximum position Only cold water

NOBILIS

The Best Technology for Water



SF00118/1	SF00118/2
RY00118/1	RY00118/2
MI102118/1	MI102118/2
SL00118/1	SL00118/2

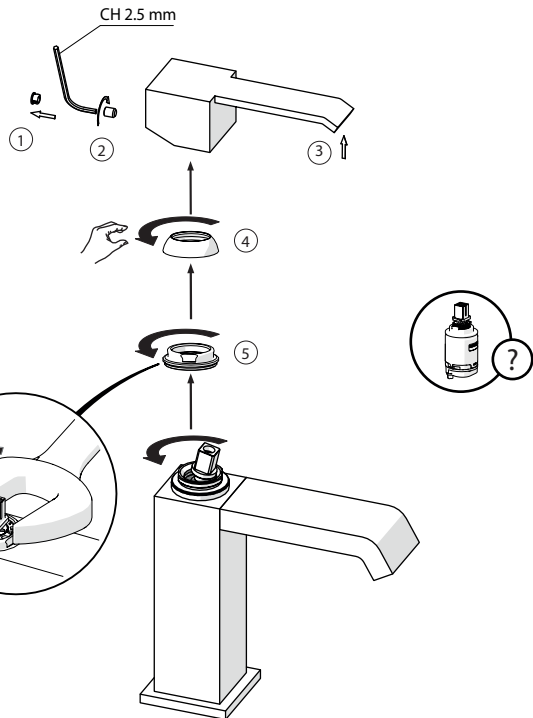
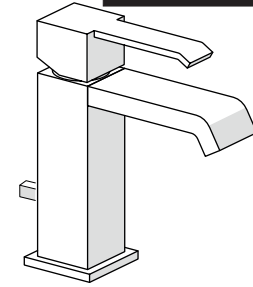

8



10

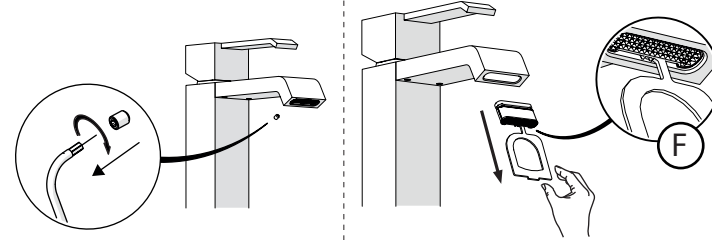

SF00118/1

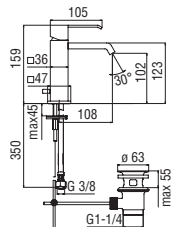

RY00118/1

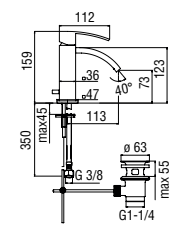

MI102118/1

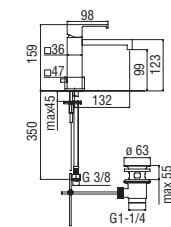

PRIMA DI INIZIARE / BEFORE STARTING



PULIZIA / CLEANING

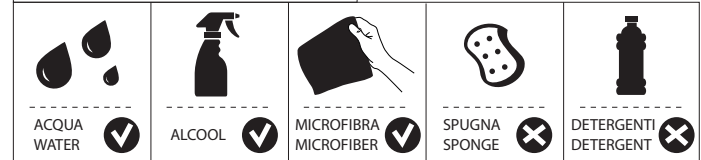

IISTRSF00118/1#--STD



REV2.07/2014

