



SPECIFICATIONS

Single control

Chrome

Anti limescale aerator M 24 x 1

1 1/4" waste with patented SNAP system

ø 3/8" stainless steel flexible pipe

Packaging: 41,5 x 16 x 7,5 cm / 0,00498 m³ / 1,9 kg

CERTIFICATIONS



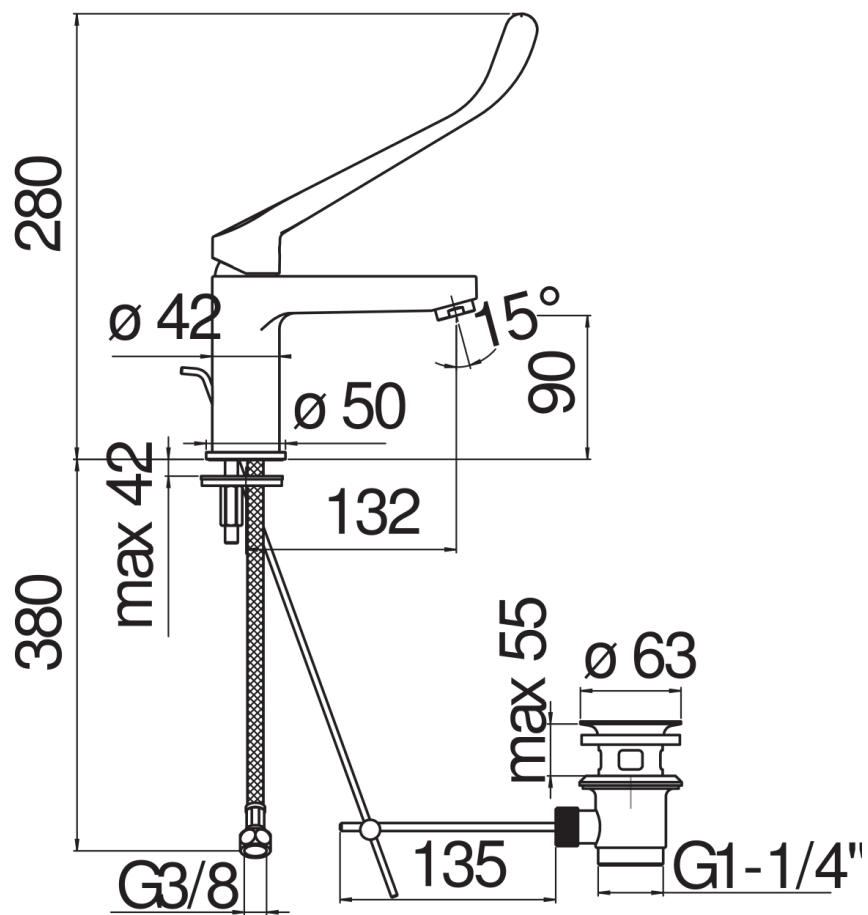

FLOW RATE DIAGRAM: HOT/COLD WATER

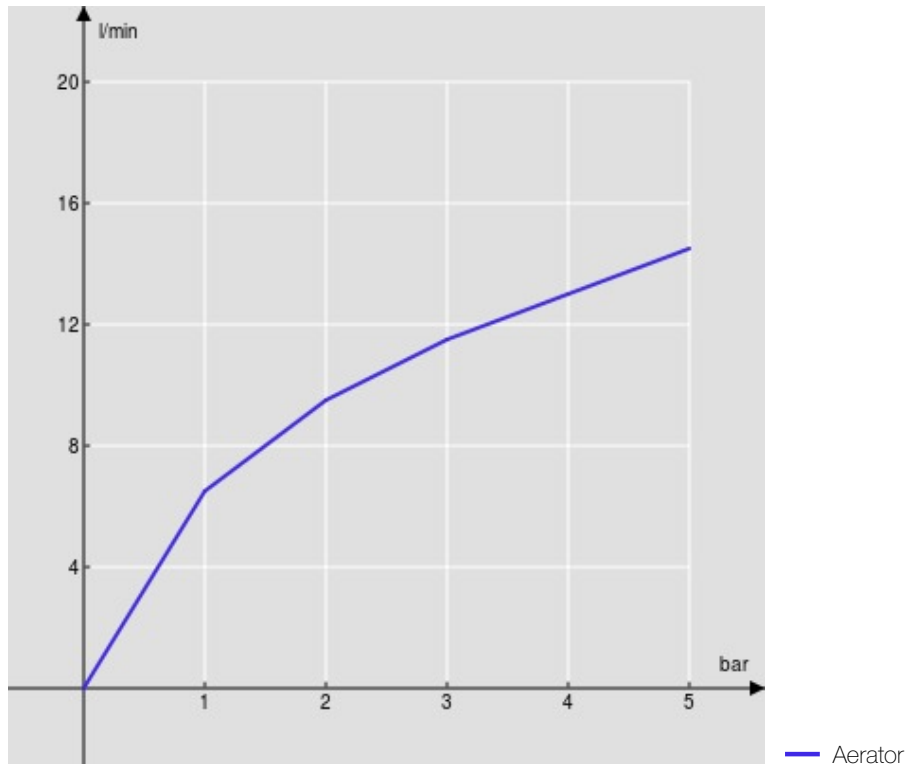

FLOW RATE DIAGRAM: MIXED WATER

