

SPECIFICATIONS

External single control

Chrome

Anti limescale aerator M 28 x 1

ø 1/2" outlet

50% two step cartridge for water saving

Packaging: 37,1 x 23,7 x 11 cm / 0,009671 m³ / 2,2 kg

CERTIFICATIONS



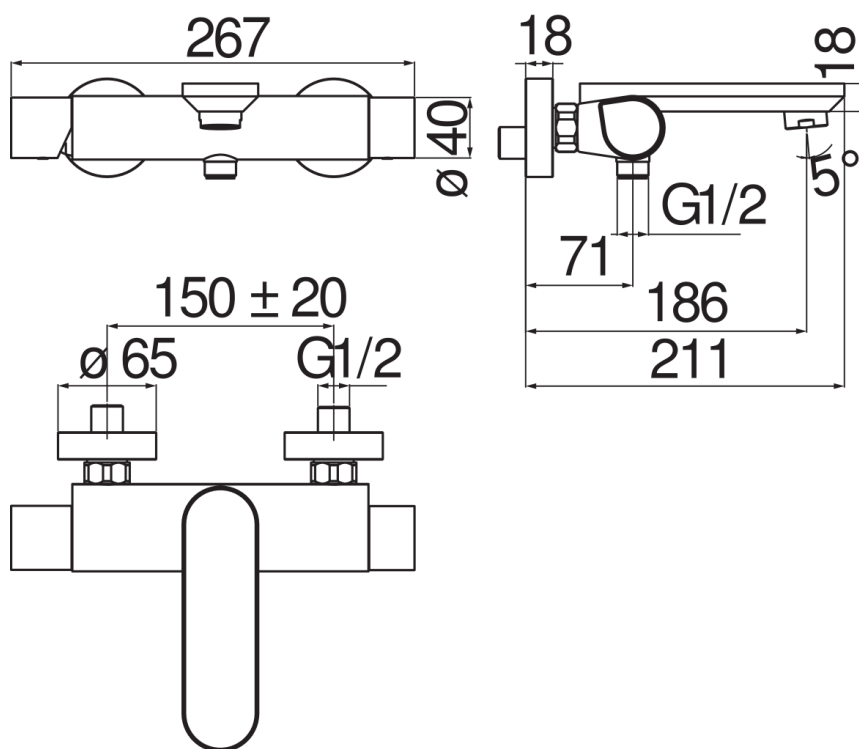

FLOW RATE DIAGRAM: HOT/COLD WATER

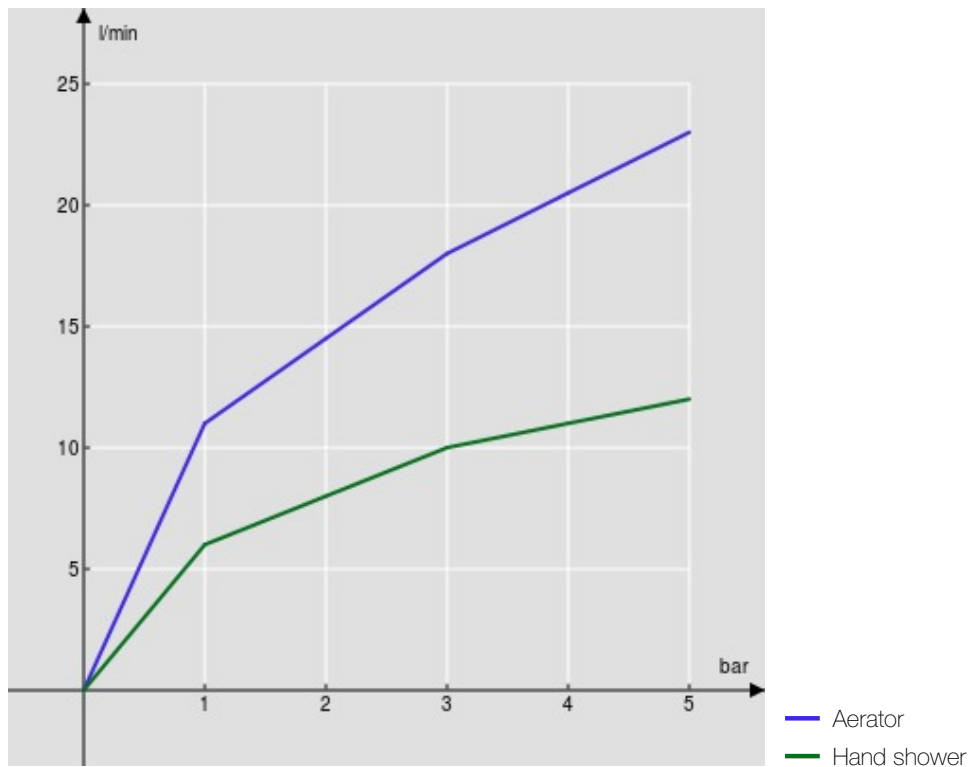

FLOW RATE DIAGRAM: MIXED WATER

