

SPECIFICATIONS

Wall-mounted single control external part long spout

Velvet black

Anti limescale aerator M 22 x 1

Length of spout 250 mm

Without waste

50% two step cartridge for water saving

Packaging: 32 x 16,5 x 7 cm / 0,0037 m³ / 0,99 kg

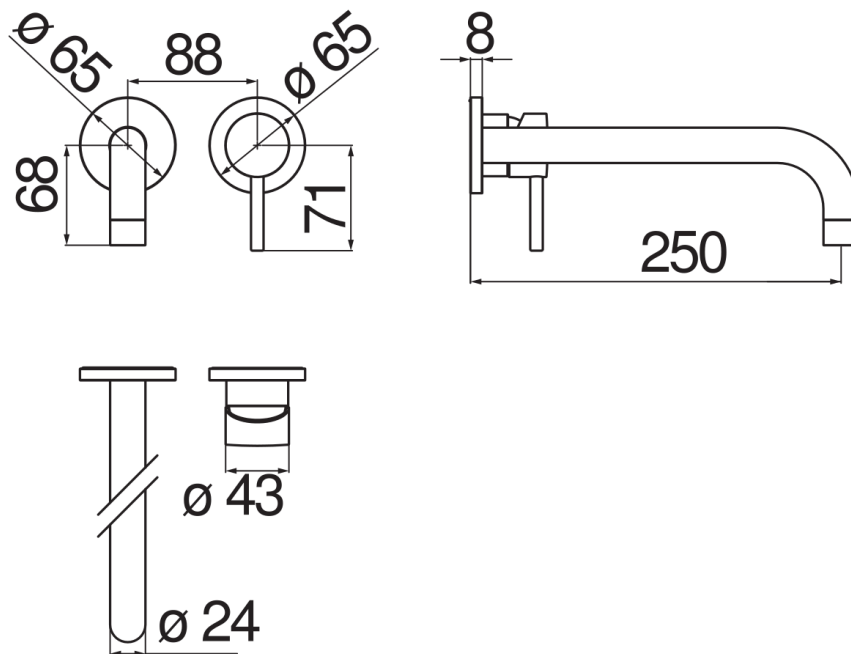

FLOW RATE DIAGRAM: HOT/COLD WATER

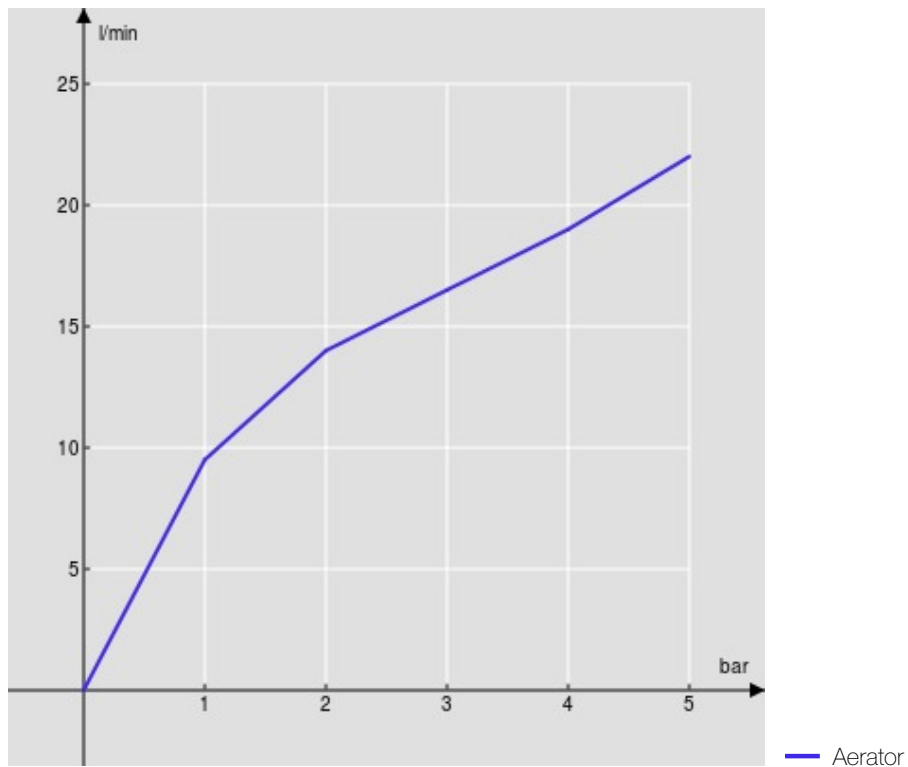

FLOW RATE DIAGRAM: MIXED WATER

