



#### SPECIFICATIONS

Built-in 2-ways single control mixer

Chrome

ø 1/2" hot and cold water inlet

ø 1/2" outlets

Auto return deviator

External part and flush-fit part

50% two step cartridge for water saving

Packaging: 22 x 15,5 x 15 cm / 0,00512 m<sup>3</sup> / 1,9 kg

#### CERTIFICATIONS



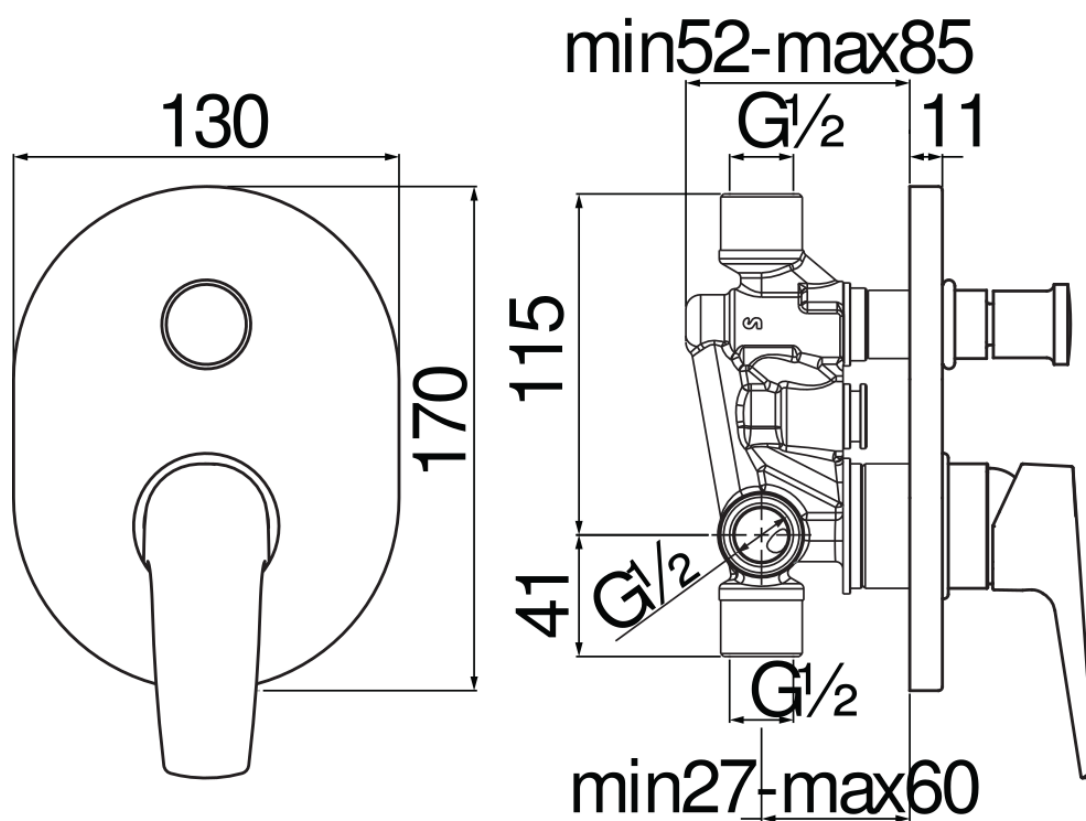

FLOW RATE DIAGRAM: HOT/COLD WATER

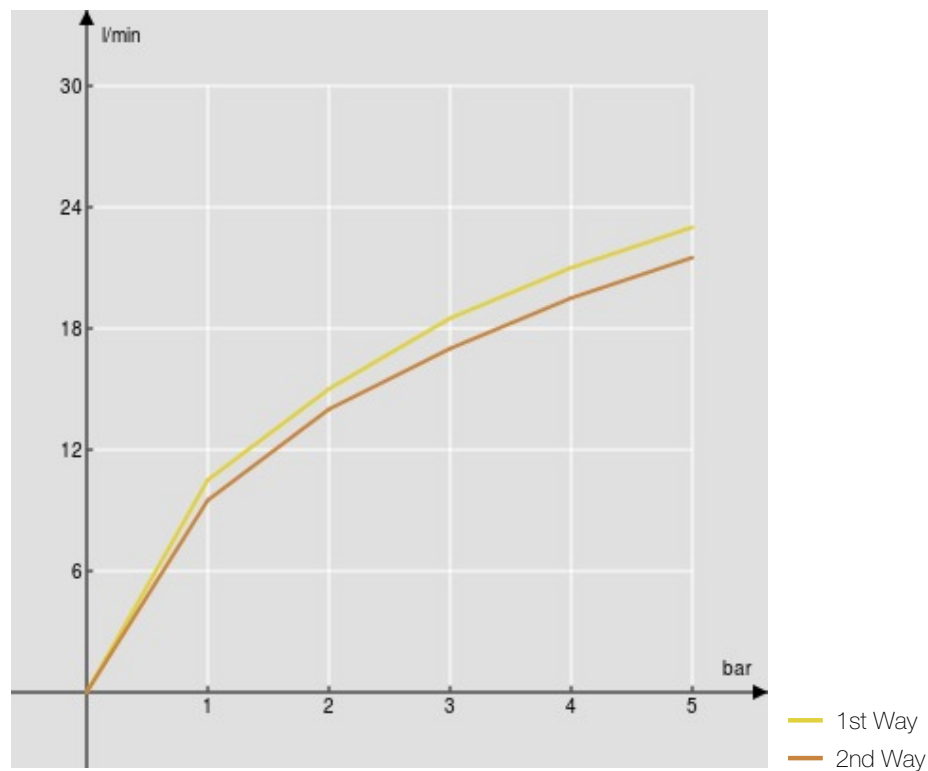

FLOW RATE DIAGRAM: MIXED WATER

