



SPECIFICATIONS

Single control
Chrome
360° swivel spout
Anti limescale aerator M 24 x 1
ø 3/8" stainless steel flexible pipe
50% two step cartridge for water saving
Packaging: 56,5 x 29 x 7,1 cm / 0,01163 m³ / 2,17 kg

CERTIFICATIONS



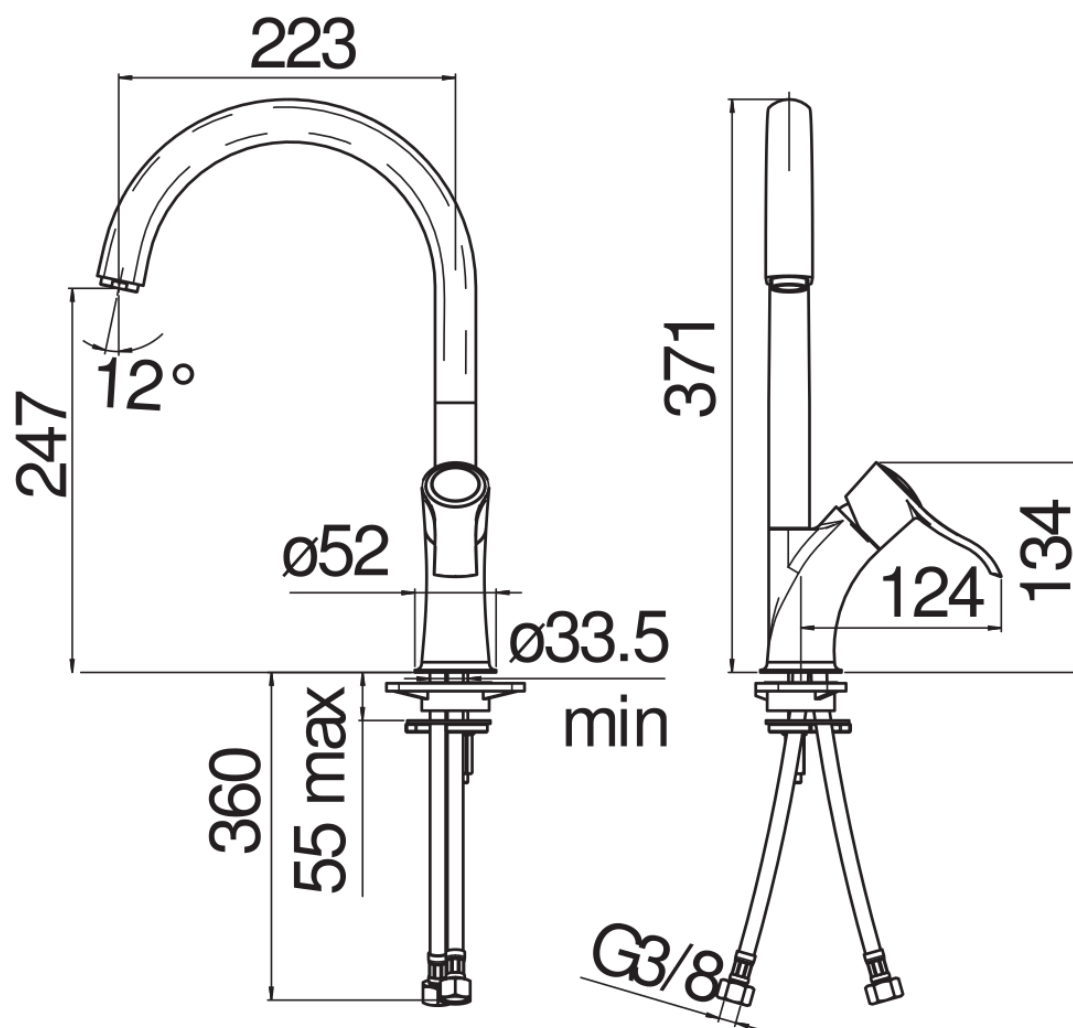

FLOW RATE DIAGRAM: HOT/COLD WATER

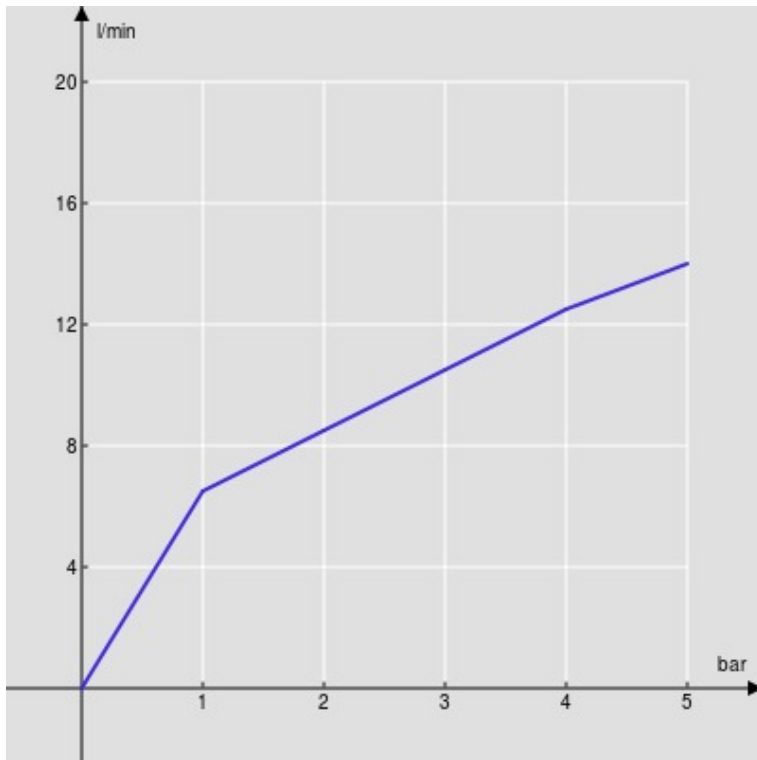

— Aerator

FLOW RATE DIAGRAM: MIXED WATER

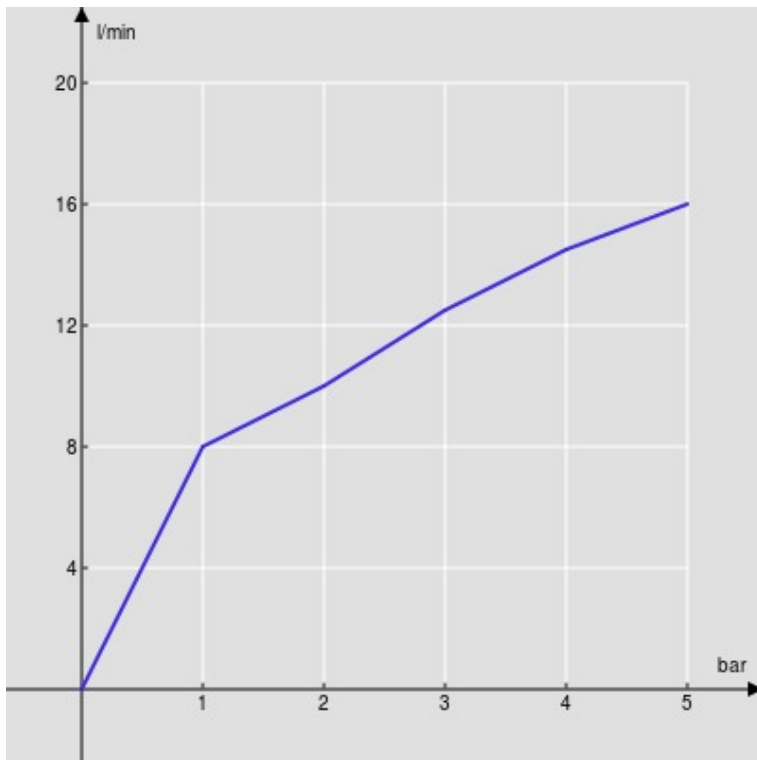

— Aerator