

Not included / Non incluso / Non Inclus / Nie zawarty/ No incluido / Nao incluido

1

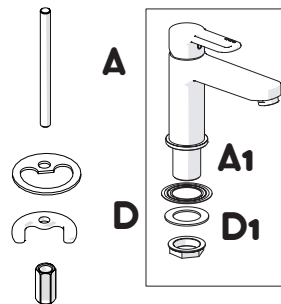

DISPONIBILE SOLO PER ALCUNE SERIE
AVAILABLE ONLY FOR SOME SERIES

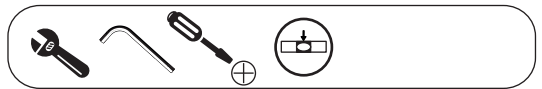
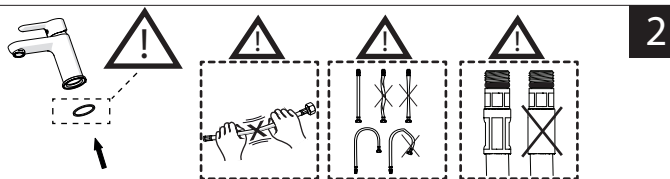
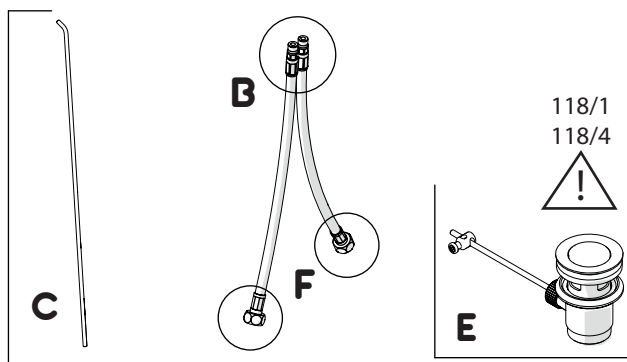

2

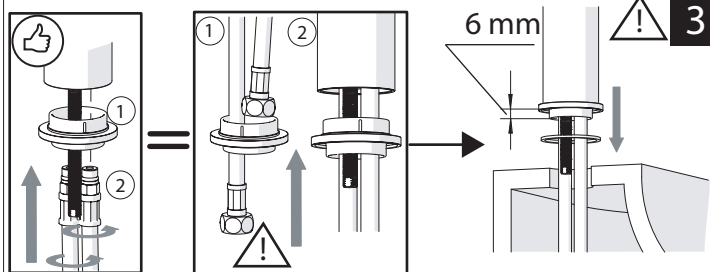
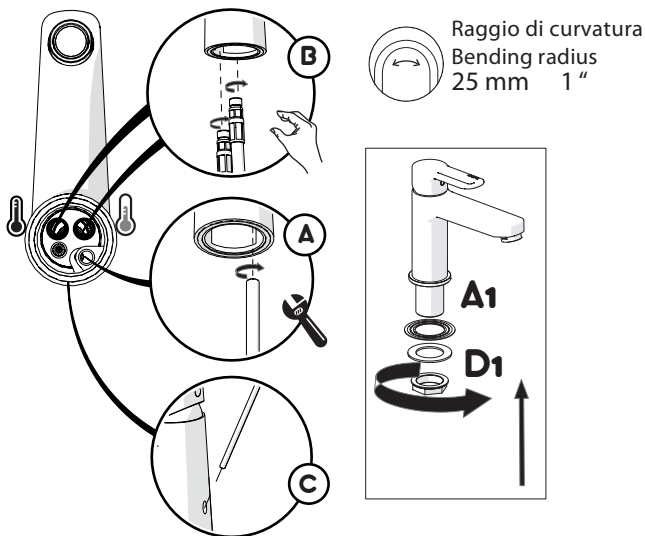

3

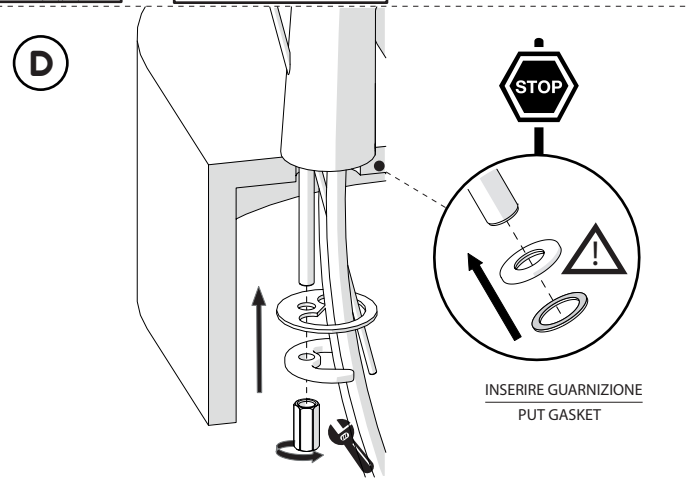

4

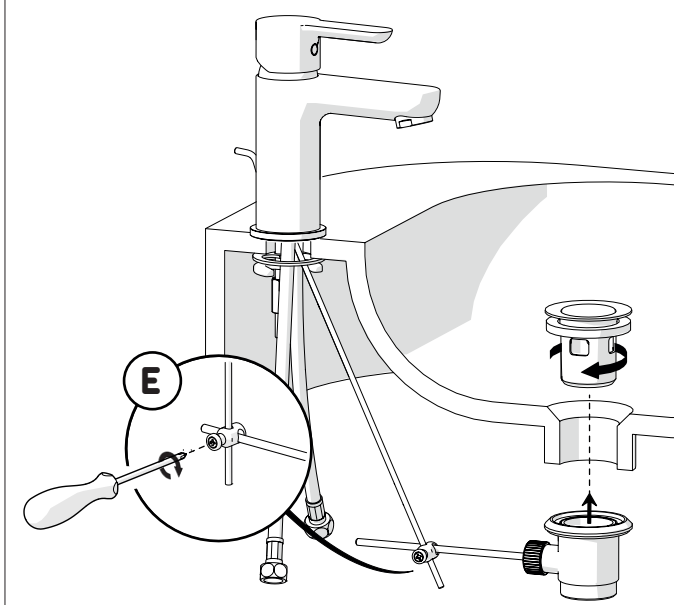

5

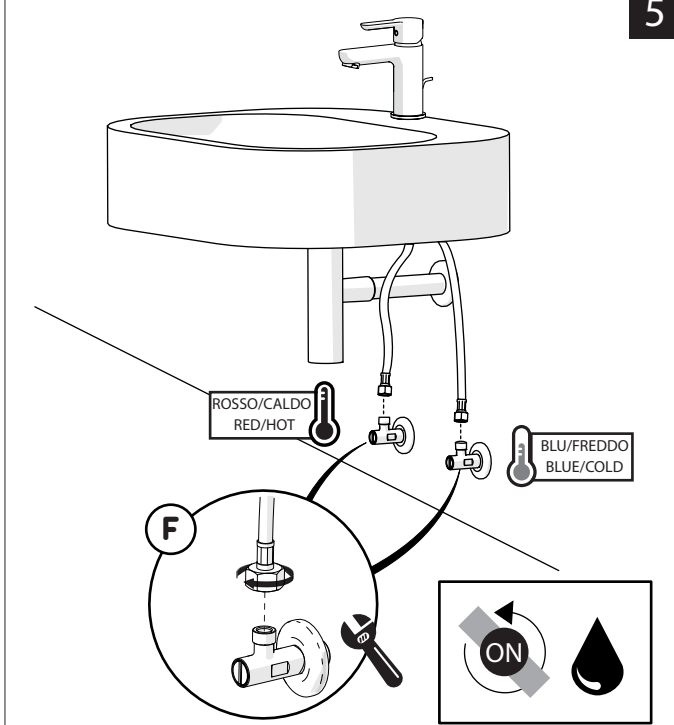

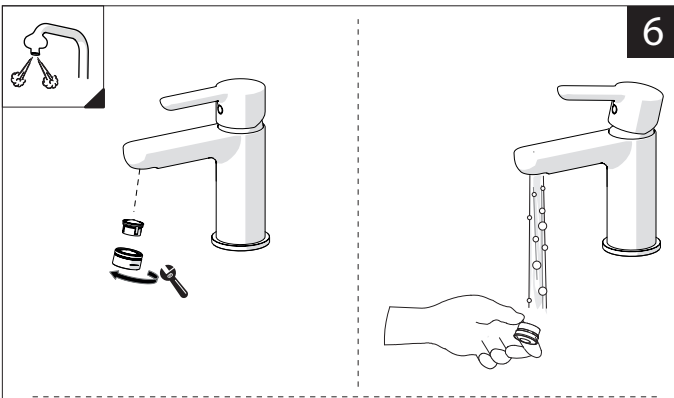

6







MAX 5,7 L/MIN
ECO

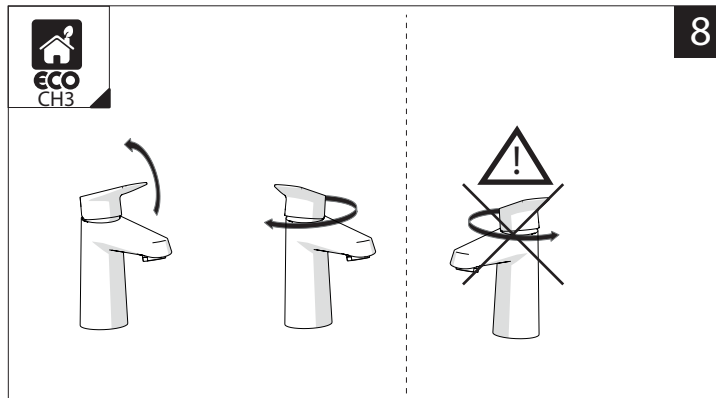

7

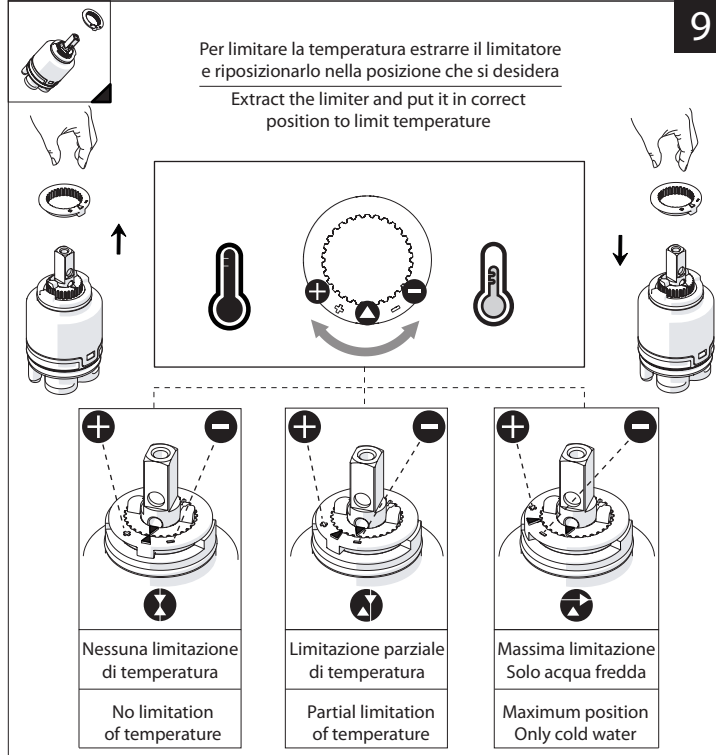
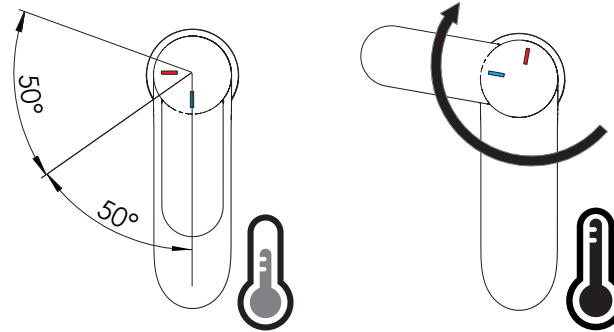

8



9



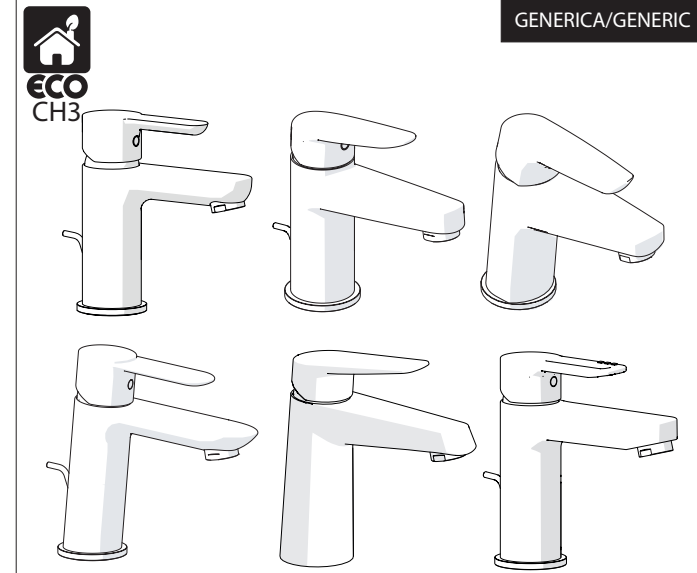





GENERICA/GENERIC









PER RUBINETTO
VERNICIATO ANTIBATTERICO NERO
RDH00118/1NBBM serie NEW ROAD
FOR TAP
BLACK ANTIBACTERIAL PAINTED
series NEW ROAD



PRIMA DI INIZIARE / BEFORE STARTING

 P	 P bar	 0,5 MIN	 MAX 10	 5	 T	 T °C	 MAX 80	 65 - 45
--	--	--	---	--	--	---	---	--

PULIZIA / CLEANING

 ACQUA WATER	 SI CROMO YES CHROME NO VERNICIATO NO PAINTED NO PVD	 MICROFIBRA MICROFIBER	 SPUGNA SPONGE	 DETERGENTI DETERGENT
 PER VERNICIATO - PVD FOR PAINTED ACQUA E SAPONE WATER AND SOAP	 ASCIUGARE BENE SEMPRE ALWAYS DRY WELL	