

-50%

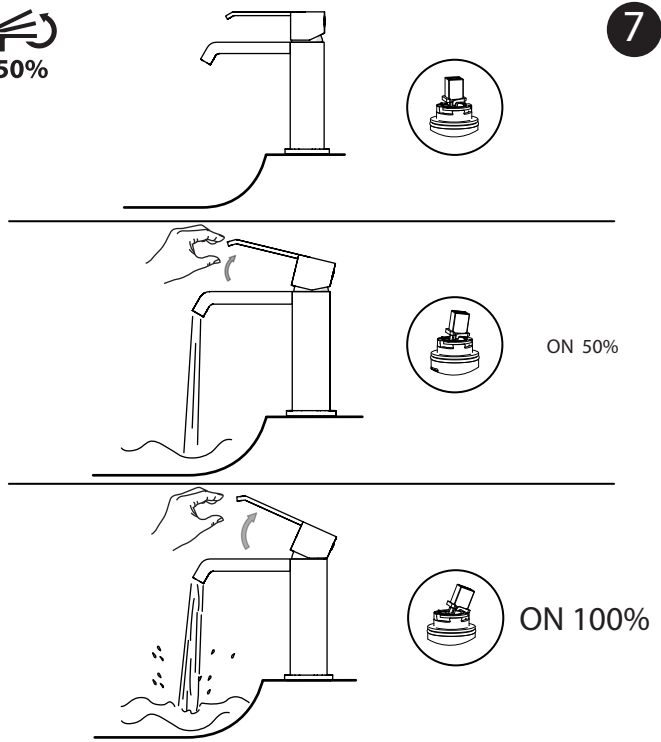

Per limitare la temperatura estrarre il limitatore e riposizionarlo nella posizione che si desidera

Extract the limiter and put it in correct position to limit temperature

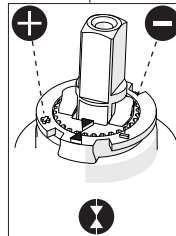
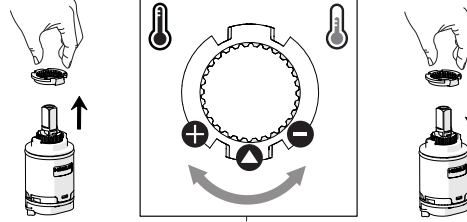

Nessuna limitazione di temperatura  
No limitation of temperature

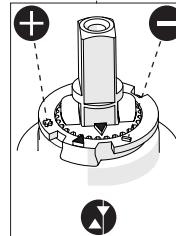

Limitazione parziale di temperatura  
Partial limitation of temperature

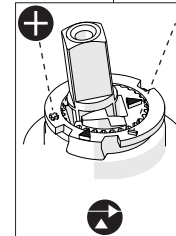

Massima limitazione Solo acqua fredda  
Maximum position Only cold water

9

**NOBILIS**<sup>®</sup>  
The Best Technology for Water



SF00118/1	SF00118/2
RY00118/1	RY00118/2
MI102118/1	MI102118/2
SL00118/1	SL00118/2

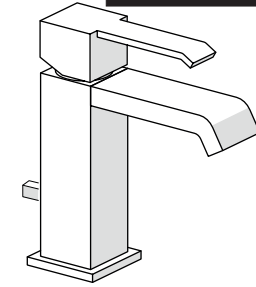

8

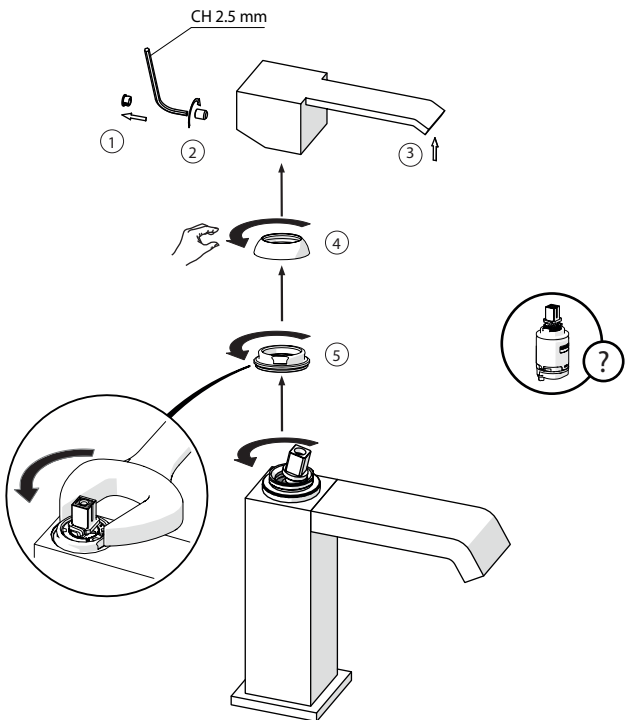

10

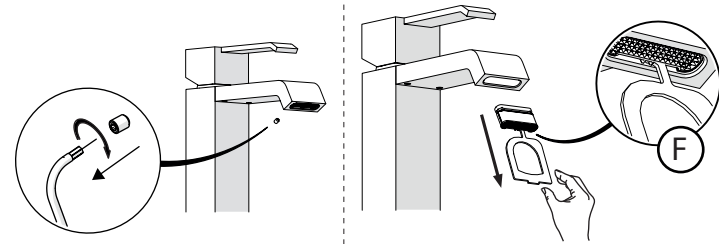

SF00118/1

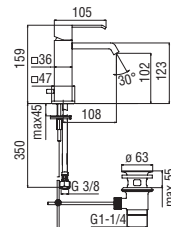

RY00118/1

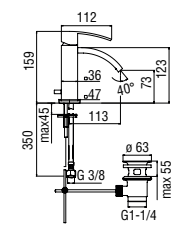

MI102118/1

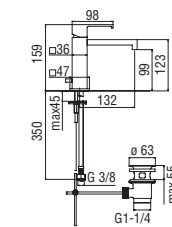

www.grupponobili.it

PRIMA DI INIZIARE / BEFORE STARTING



PULIZIA / CLEANING

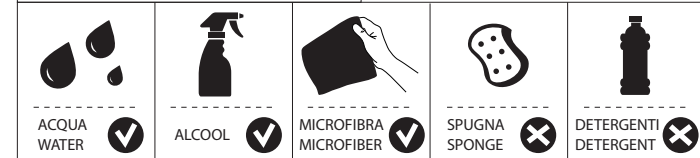

IISTRSF00118/1#--STD



REV2.07/2014

