

Not included / Non incluso / Non Inclus / Nie zawarty / No incluido / Nao incluido

1

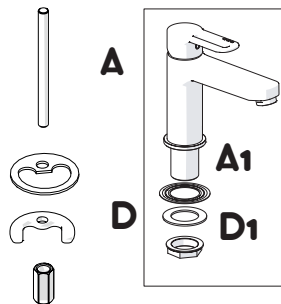

DISPONIBILE SOLO PER ALCUNE SERIE  
AVAILABLE ONLY FOR SOME SERIES

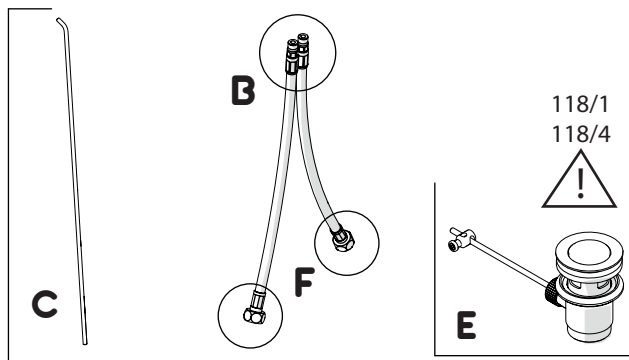
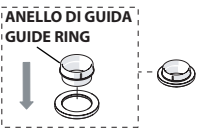

118/1  
118/4

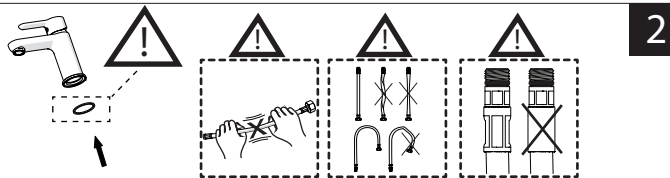

2

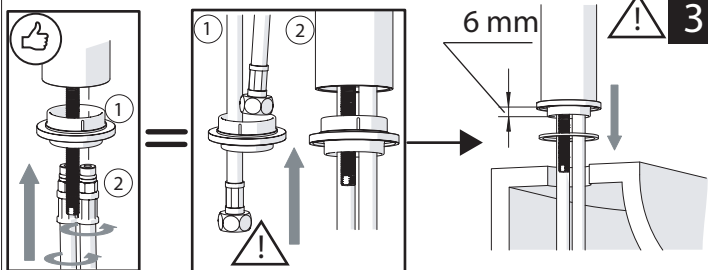
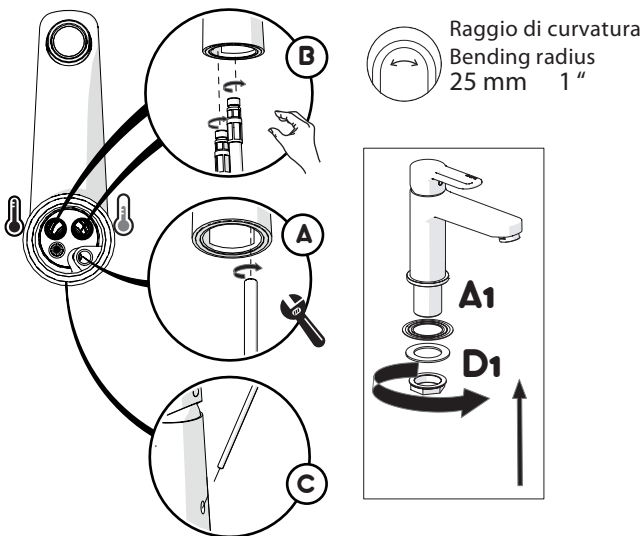

3

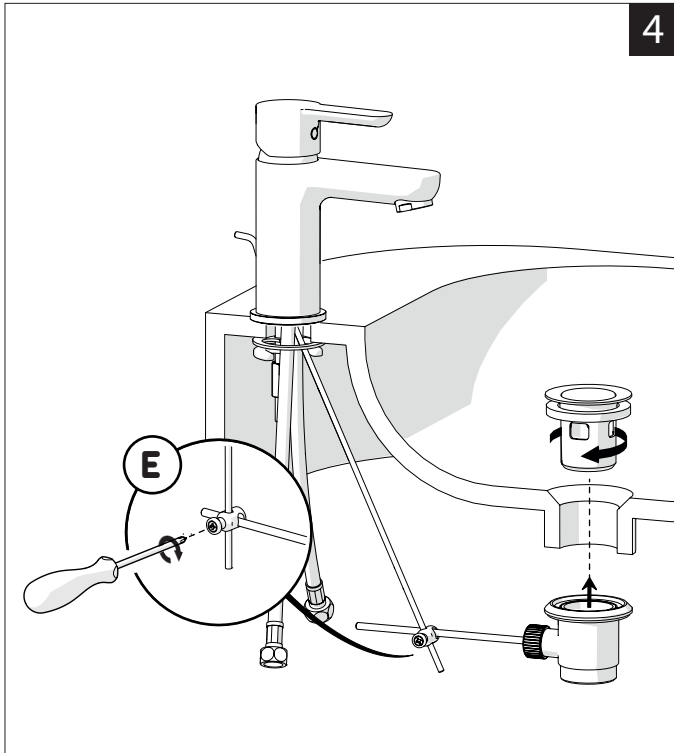
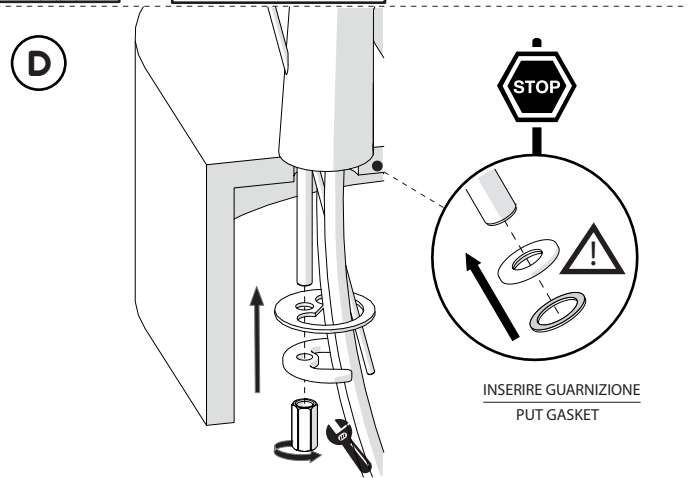

4

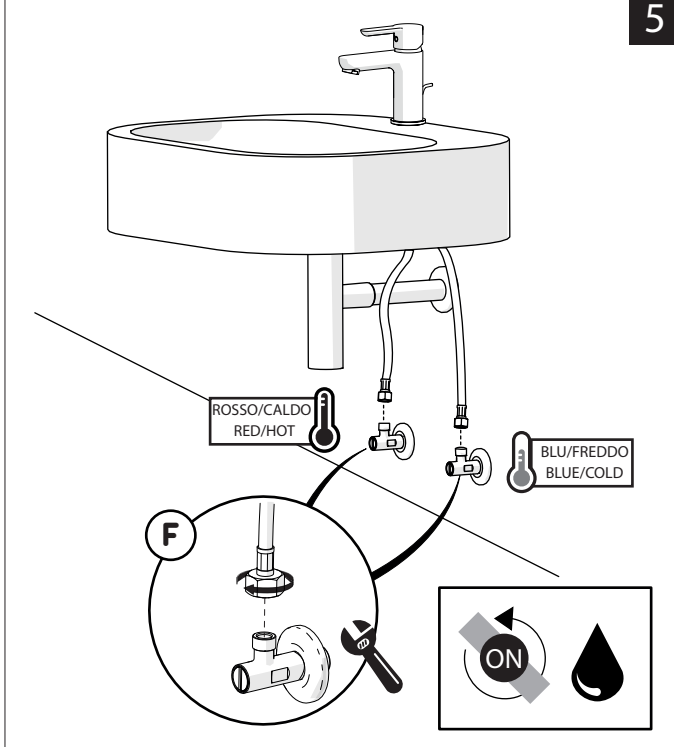

5

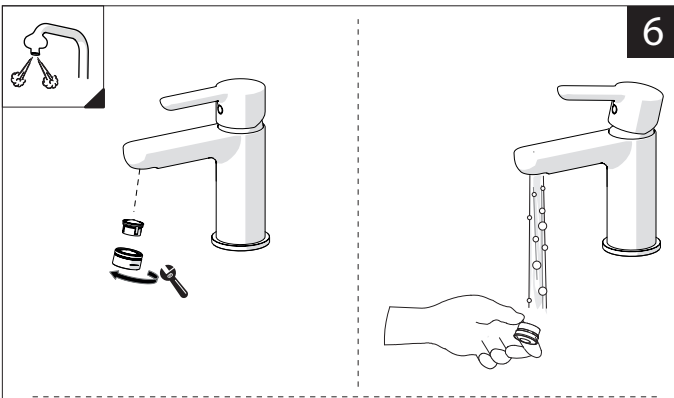

6



  
**MAX 5,7 L/MIN**  
**ECO**



7

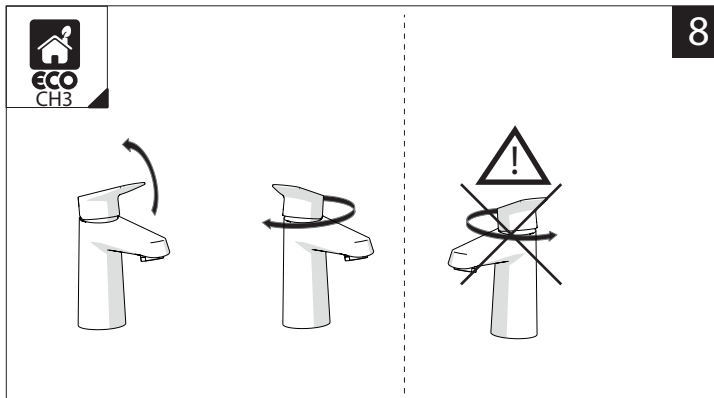

8

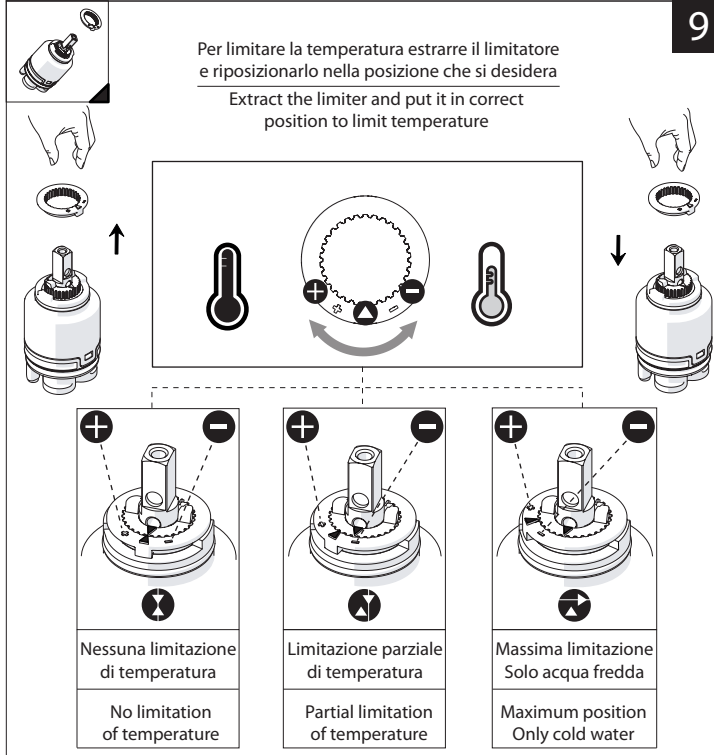
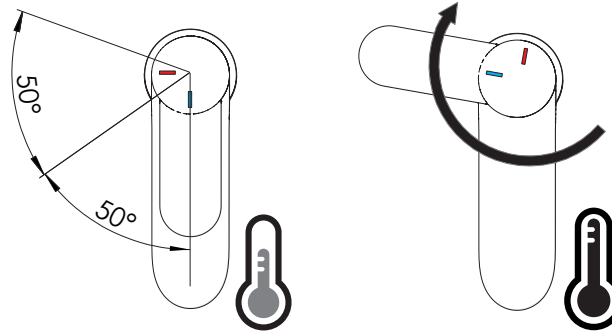

9



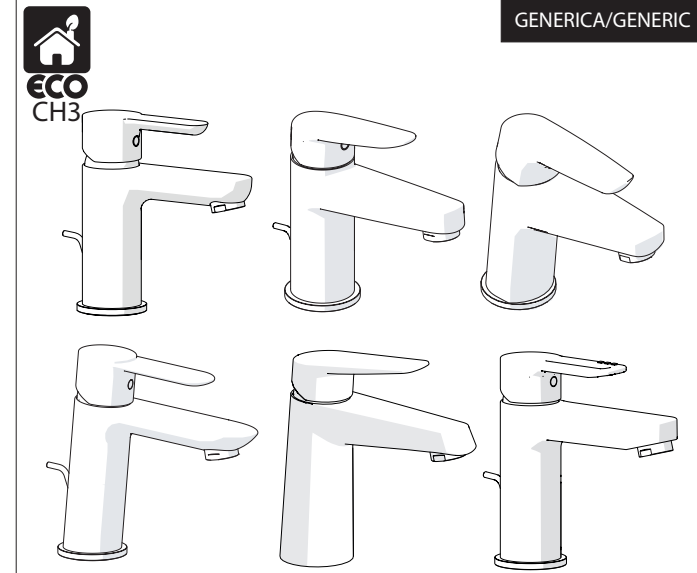





GENERICA/GENERIC











  
**PER RUBINETTO**  
**VERNICIATO ANTIBATTERICO NERO**  
**RDH00118/1NBBM serie NEW ROAD**  
**FOR TAP**  
**BLACK ANTIBACTERIAL PAINTED**  
**series NEW ROAD**



**PRIMA DI INIZIARE / BEFORE STARTING**

 P	 P	 0,5 MIN	 MAX 10	 5	 T	 T °C	 MAX 80	 65 - 45
--	--	--	---	--	--	---	---	--

**PULIZIA / CLEANING**

 ACQUA WATER	 SI CROMO YES CHROME NO VERNICIATO NO PAINTED NO PVD	 MICROFIBRA MICROFIBER	 SPUGNA SPONGE	 DETERGENTI DETERGENT
 PER VERNICIATO - PVD FOR PAINTED ACQUA E SAPONE WATER AND SOAP	 ASCIUGARE BENE SEMPRE ALWAYS DRY WELL	