

Not included / Non incluso / Non Inclus / Nie zawarty/ No incluido / Nao incluido

1

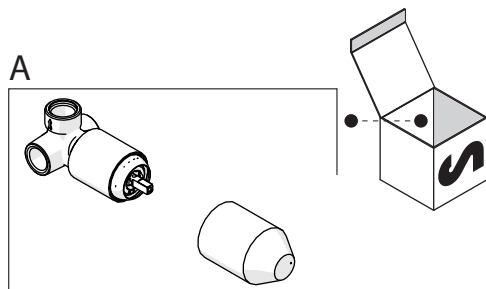

B1

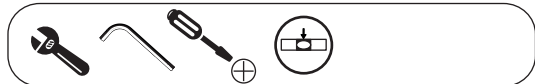
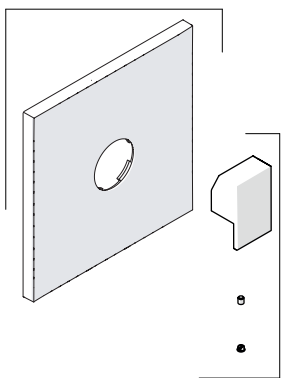

B2

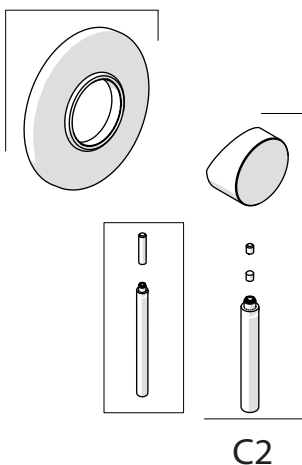

C1

C2



2

(A)

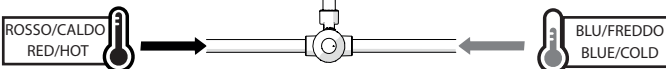
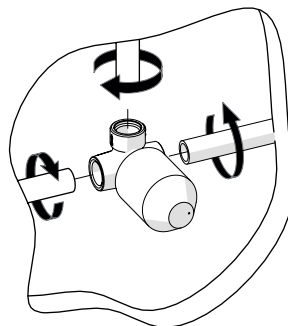

TEST PER I TUBI
PRIMA DELLA CARTUCCIA (A)
TEST FOR THE PIPES
BEFORE CARTRIDGE (A)

ATTENZIONE!
Durante il test la cartuccia deve essere
in posizione "chiusa"!

ATTENTION!
During test cartridge must be
placed in "CLOSED POSITION"

3



TEST PER I TUBI
DOPO LA CARTUCCIA (B)
TEST FOR THE PIPES
AFTER CARTRIDGE (B)

ATTENZIONE!
Secondo la norma europea EN817, in caso
di test per i tubi dopo la cartuccia, la pressione
deve essere a 4 bar per 1 minuto e la cartuccia
in posizione "aperta"

ATTENTION!
As per european rule EN817, in
case of test for the pipes after
cartridge, the pressure must be
within 4 bar for 1 minute and the
cartridge in "open position"

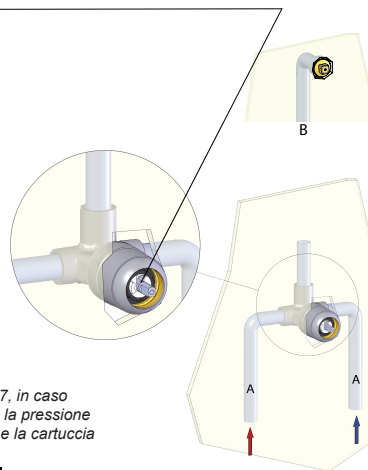

4

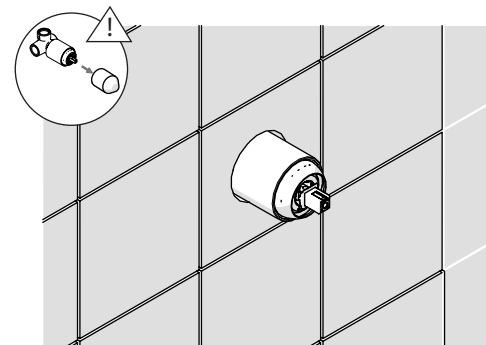
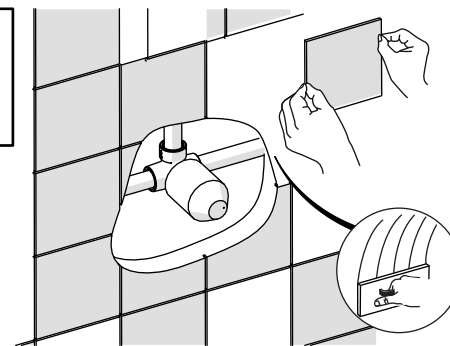

5

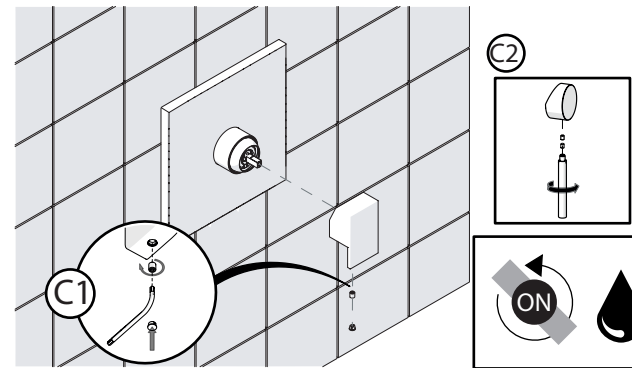
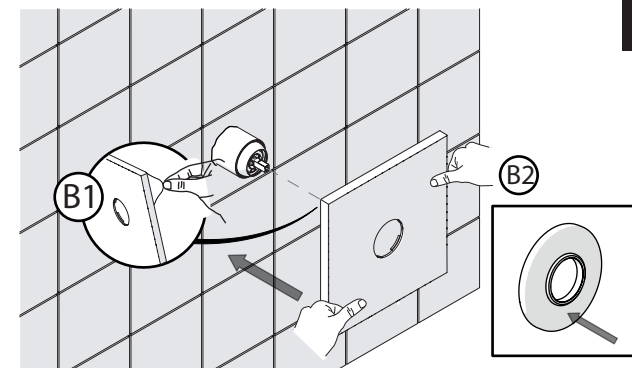



Dispositivo limitatore "dinamico" della portata d'acqua "50%"
"Dynamic" flow rate restrictor "50%"

6

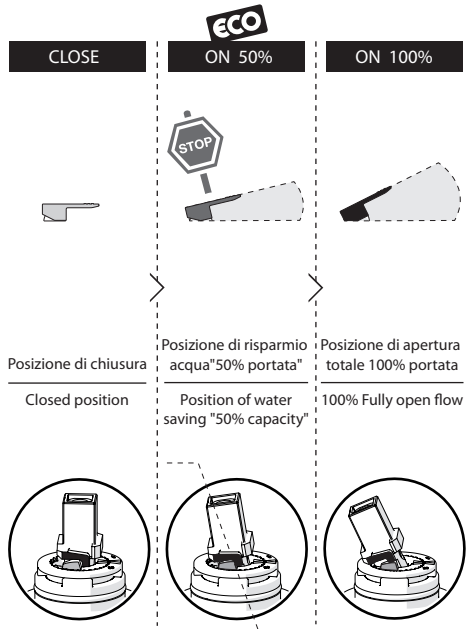

Per limitare la temperatura estrarre il limitatore e riposizionarlo nella posizione che si desidera
Extract the limiter and put it in correct position to limit temperature

8

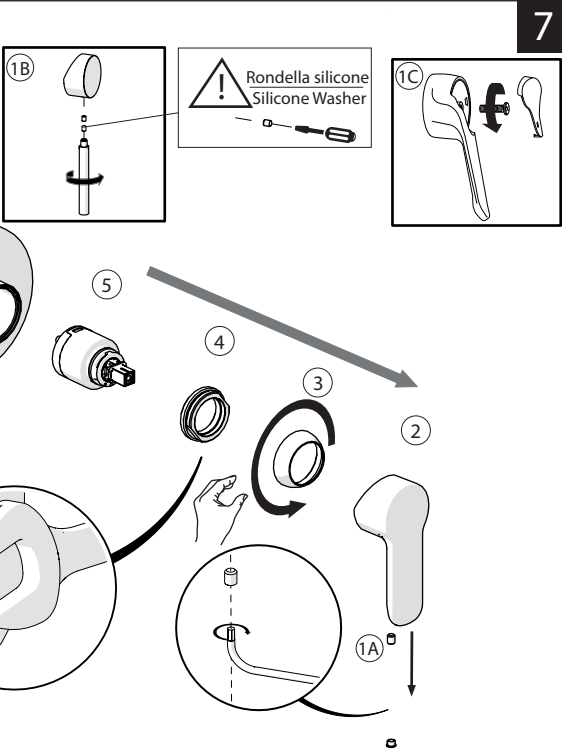
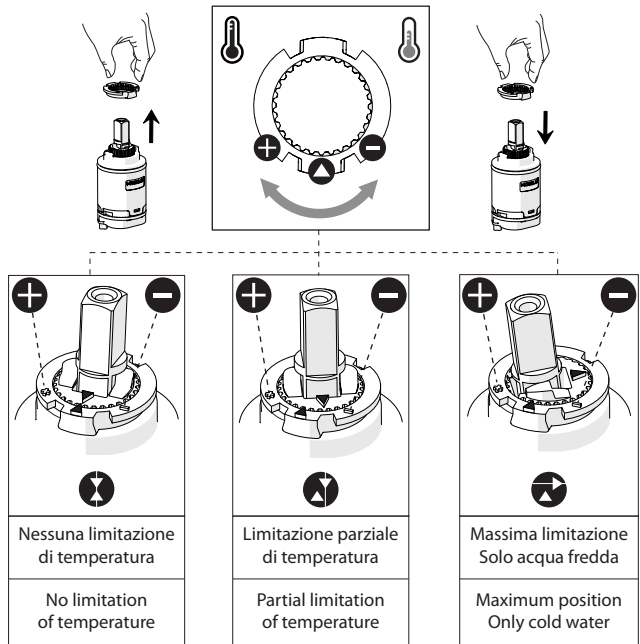

7



ESEMPI DISEGNO TECNICO
EXAMPLES OF TECHNICAL DRAWING

9

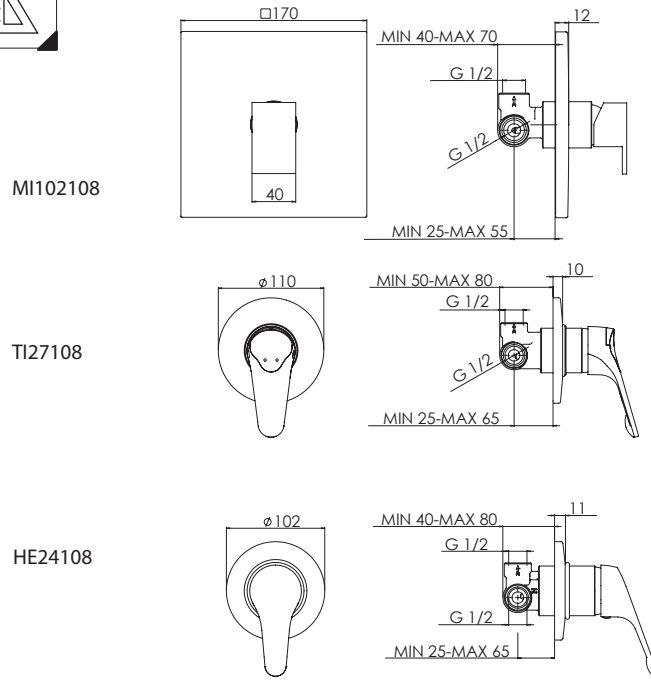

NOBILIS

108

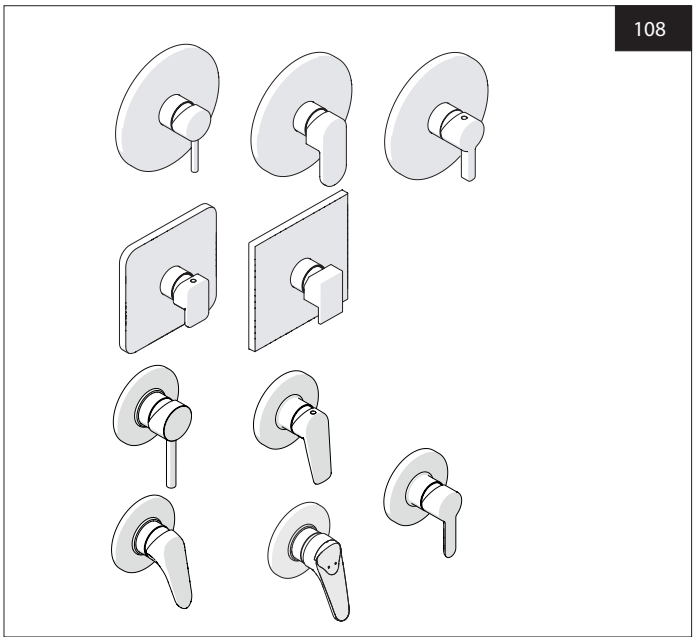

www.nobili.it

PRIMA DI INIZIARE / BEFORE STARTING

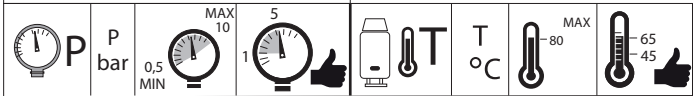

PULIZIA / CLEANING



IISTR00108#---STD



REV4.01/2018