

+

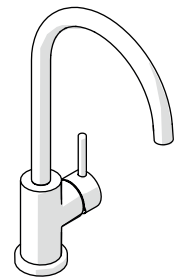

+

Not included / Non incluso / Non inclus / Nie zawarty / No incluido / Não incluido



A

C1

C

B

D

1

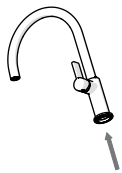

A

3

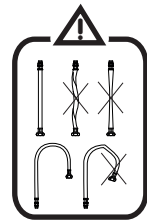

B

INSERIRE GUARNIZIONE  
PUT GASKET

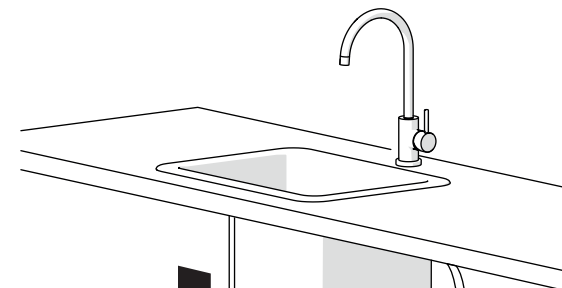

5

D

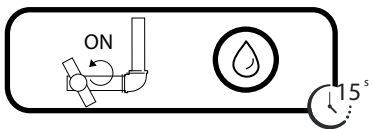
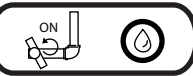

2

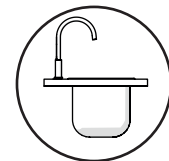
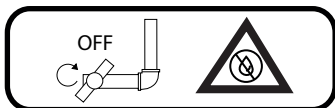
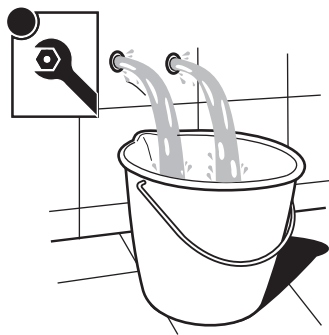

C

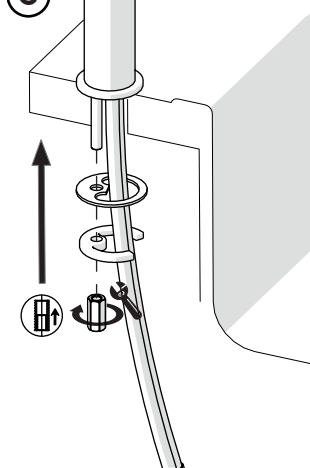

4

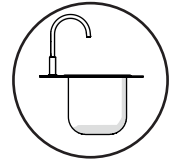

C1

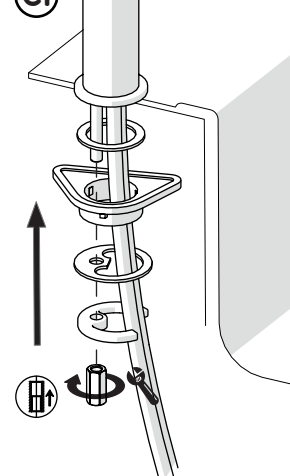

-50%

6

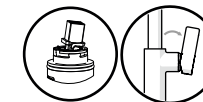
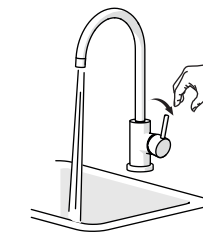

ON 50%



ON 100%

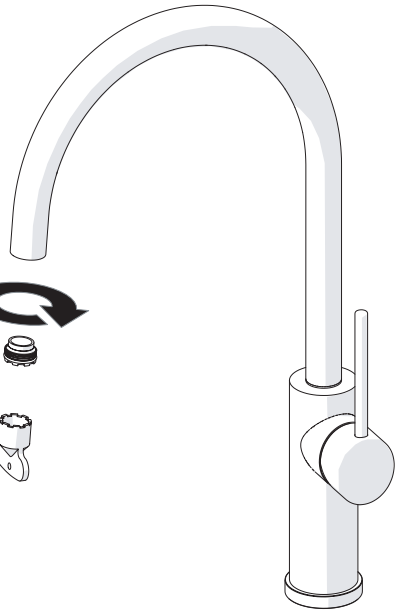
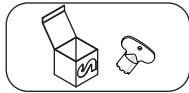
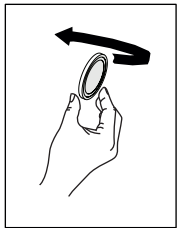

7

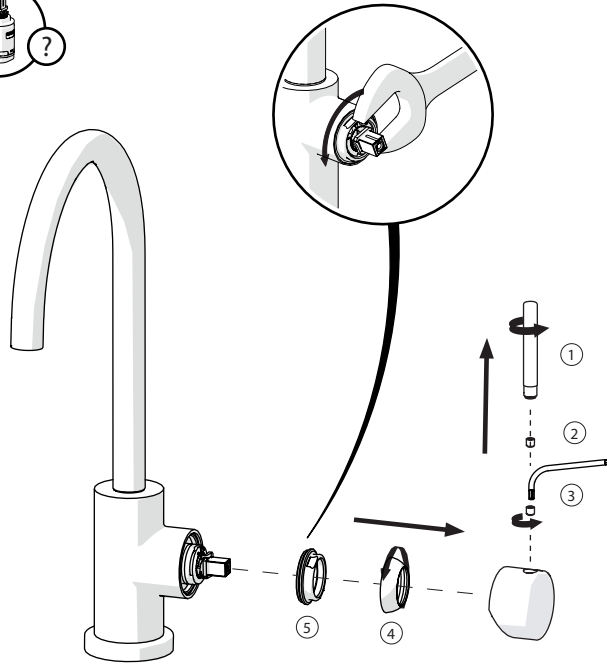

9

**NOBILIS**  
The Best Technology for Water

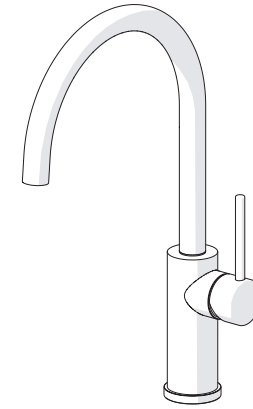

IISTRWB00113#---STD

www.grupponobili.it

REV1.04/2015

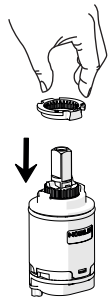
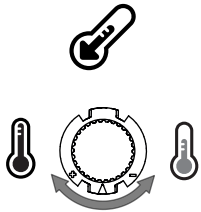
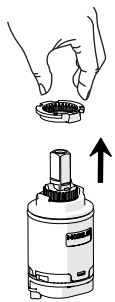

8

No limitation of temperature

Partial limitation of temperature

Maximum position Only cold water

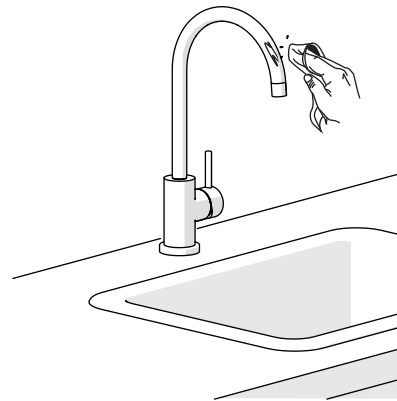
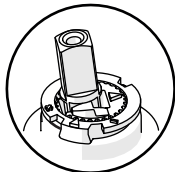
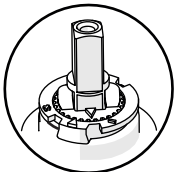
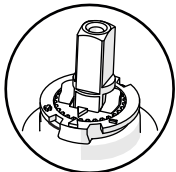

CLEANING

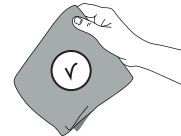
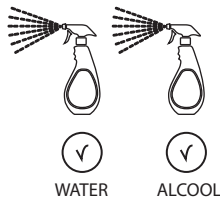

10

