



SPECIFICHE

Termostatico esterno con rampa telescopica

Chrome

Blocco di sicurezza 38° C

Valvoline antiritorno

Soffione a snodo ø 200 mm

Supporto doccetta scorrevole e orientabile

Doccetta monogetto e flessibile 150 cm

Imballo: 117 x 42 x 8,5 cm / 0,04177 m³ / 8,48 kg

CERTIFICAZIONI





DIAGRAMMA DI PORTATA: ACQUA CALDA/FREDDA



DIAGRAMMA DI PORTATA: ACQUA MISCELATA

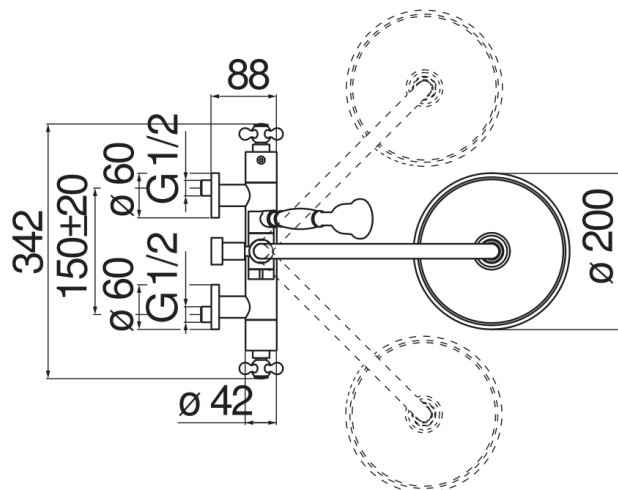
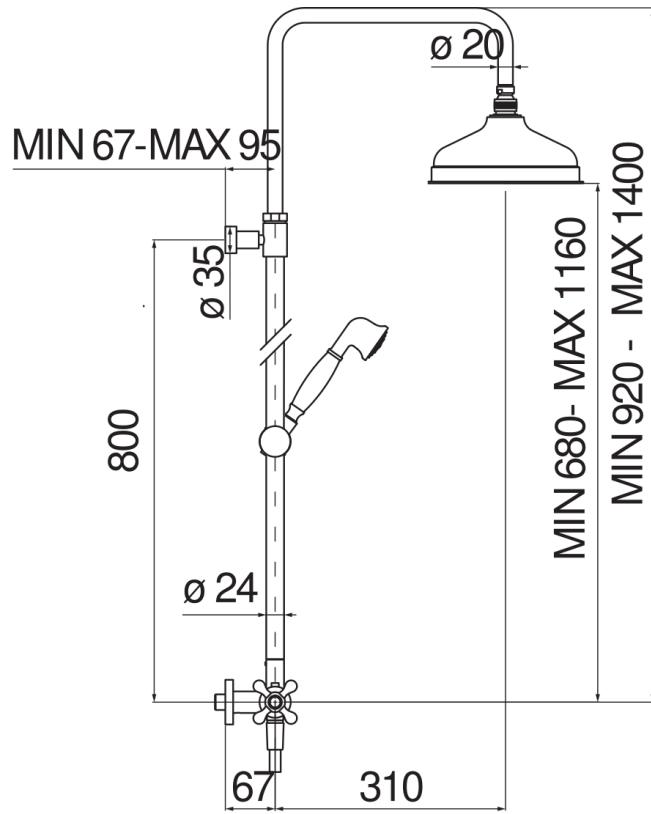
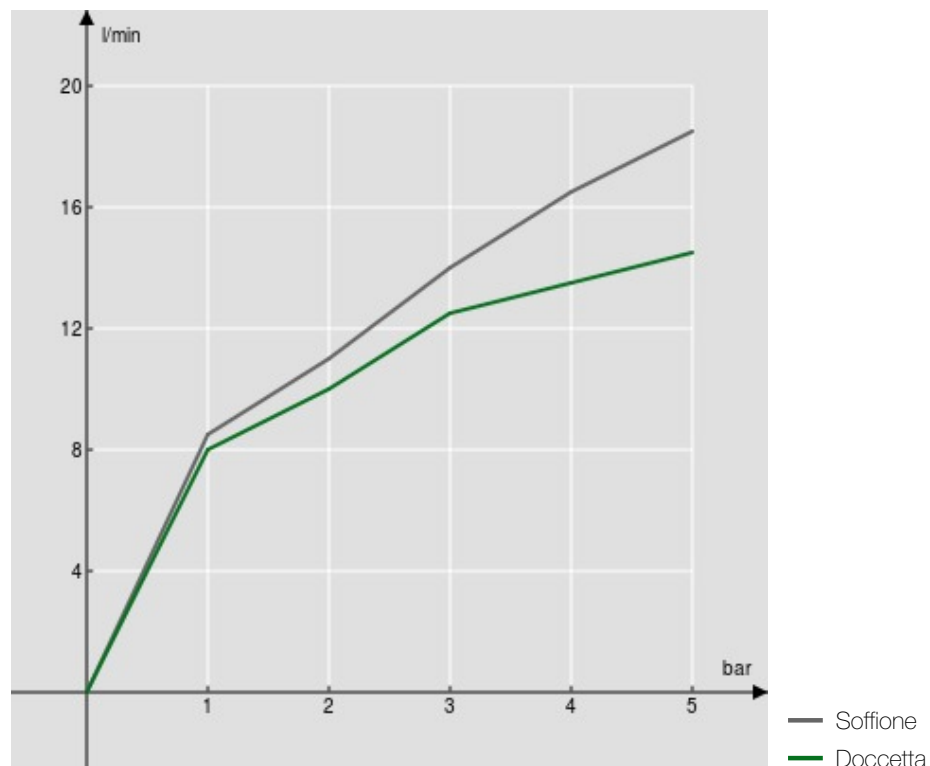