

-50%

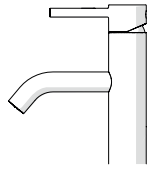

7

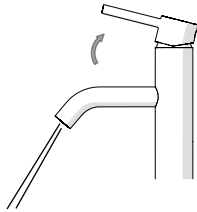

ON 50%

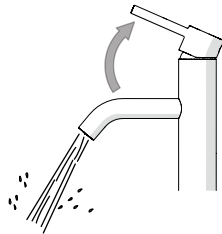

ON 100%

9

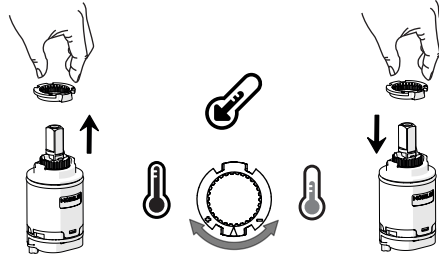

No limitation of temperature

Partial limitation of temperature

Maximum position Only cold water

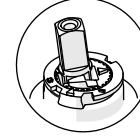
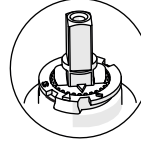
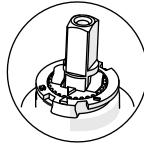

NOBILIS®
The Best Technology for Water

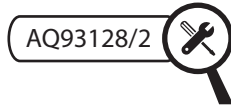
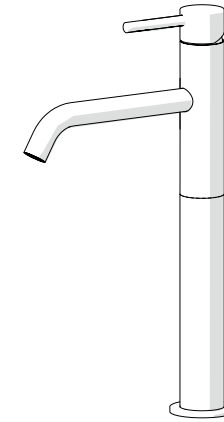

IISTRAQ93128/2#---STD

www.grupponobili.it

REV1.05/2013



1 2

8

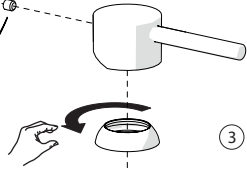
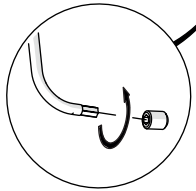

3 4 5

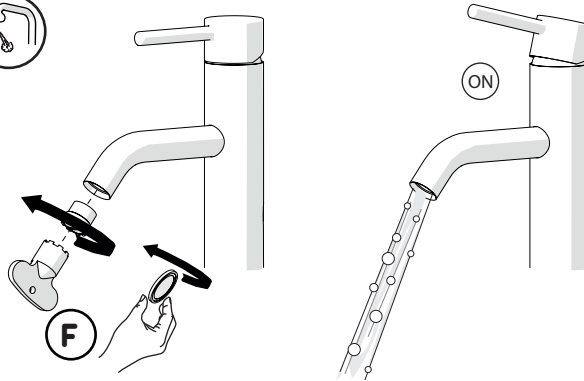
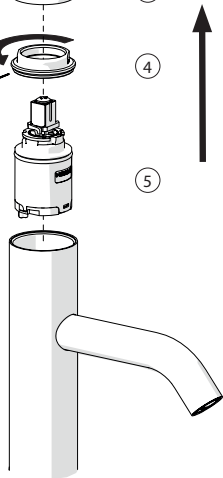
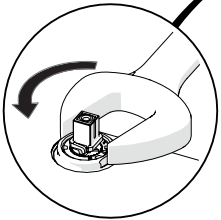

10

CLEANING

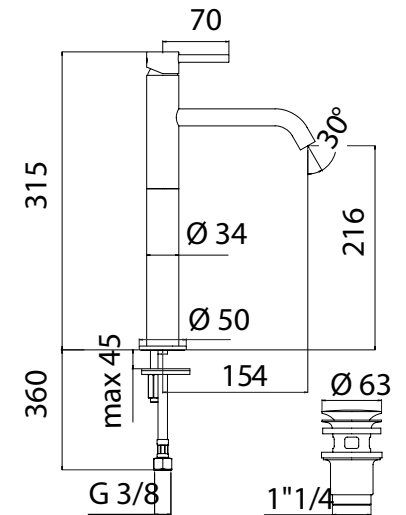
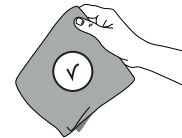
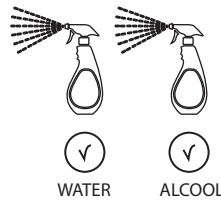

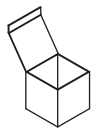

+



Not included / Non incluso / Non inclus / Nie zawarty / No incluido / Nao incluido

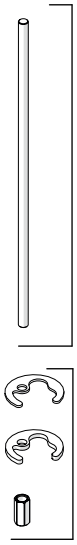

A

C

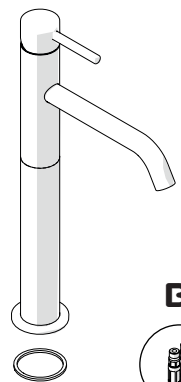

B

non incluso
not included

1

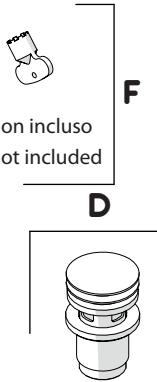

F

D

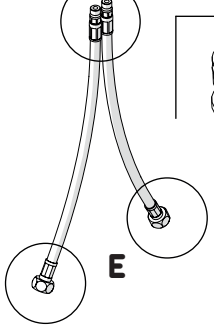

E

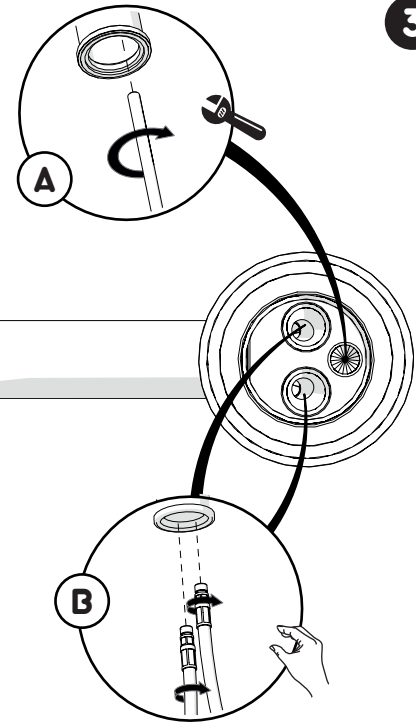
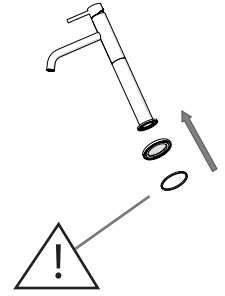
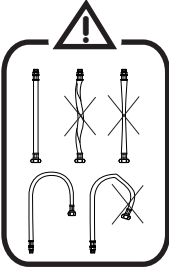

3

A

B

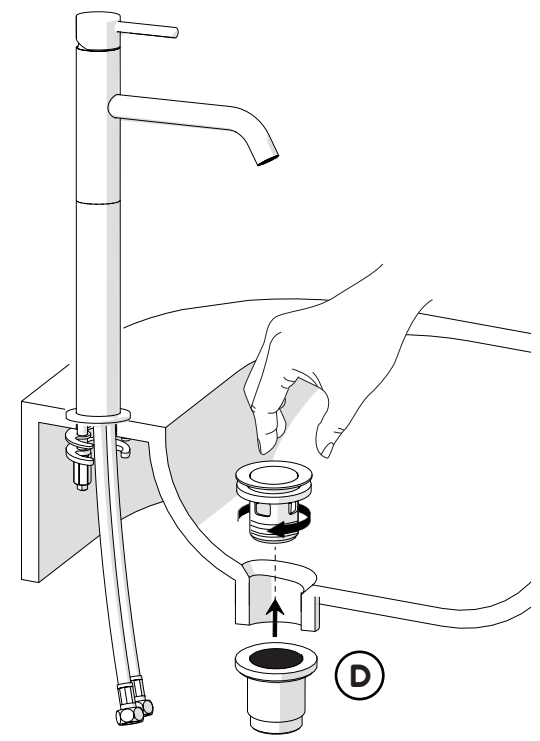

5

D

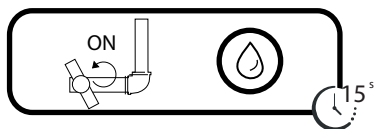

2

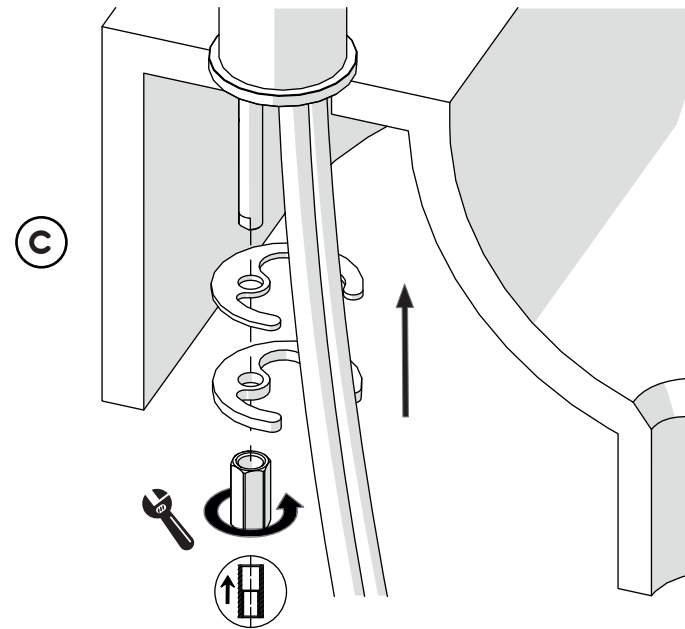
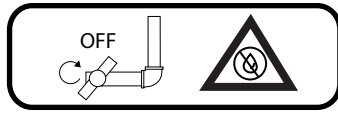
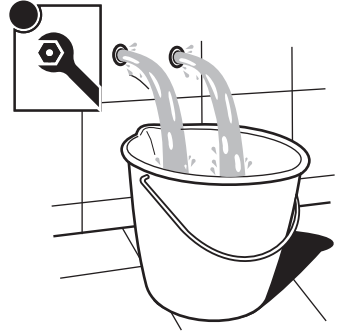

4

C

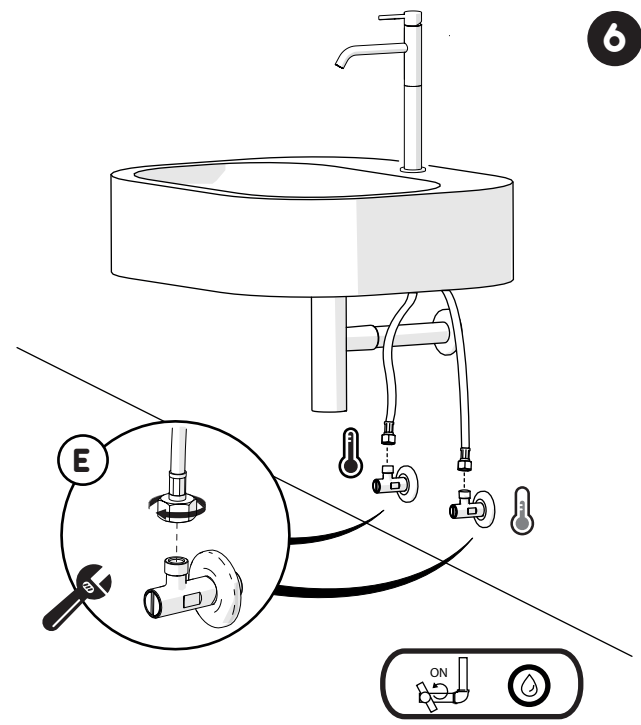

6

E

