

Not included / Non incluso / Non Inklus / Nie zawarty/ No incluido / Nao incluido

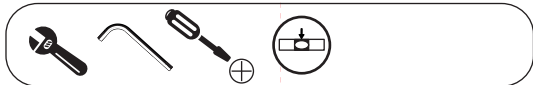

1

A

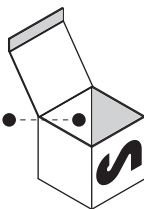
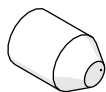

B

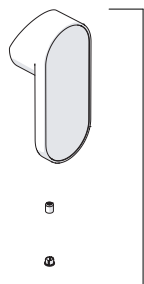
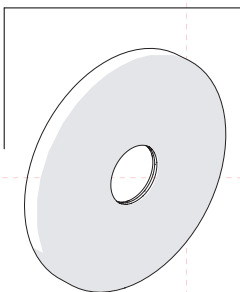

C

GUARNIZIONE DI RICAMBIO
SPARE PART GASKET

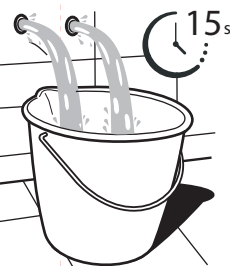
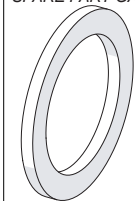

15s

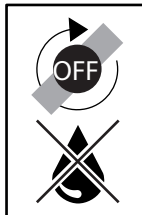
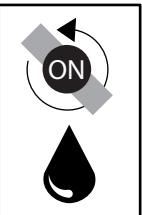

2



A

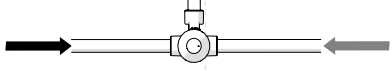
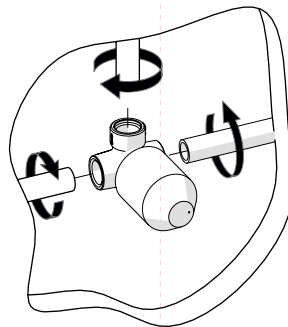

TEST PER I TUBI
PRIMA DELLA CARTUCCIA (A)
TEST FOR THE PIPES
BEFORE CARTRIDGE (A)

ATTENZIONE!
Durante il test la cartuccia deve essere
in posizione "chiusa"!

ATTENTION!
During test cartridge must be
placed in "CLOSED POSITION"



TEST

TEST PER I TUBI
DOPO LA CARTUCCIA (B)

TEST FOR THE PIPES
AFTER CARTRIDGE (B)

ATTENZIONE!
Secondo la norma europea EN817, in caso
di test per i tubi dopo la cartuccia, la pressione
deve essere a 4 bar per 1 minuto e la cartuccia
in posizione "aperta"

ATTENTION!
As per european rule EN817, in
case of test for the pipes after
cartridge, the pressure
must be within 4 bar for 1 minute and the
cartridge in "open position"

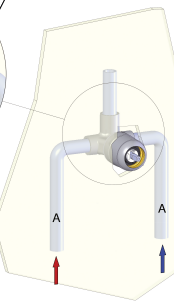
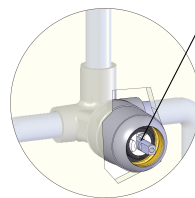

3

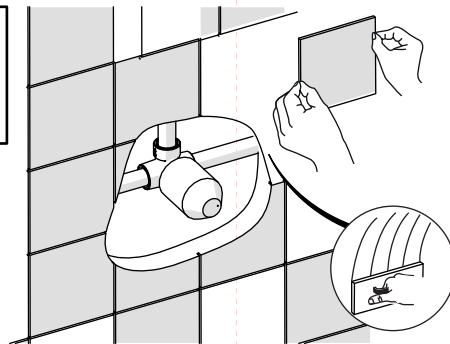

4

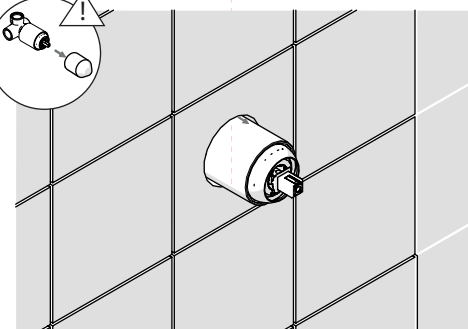
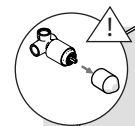

5

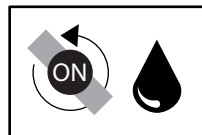
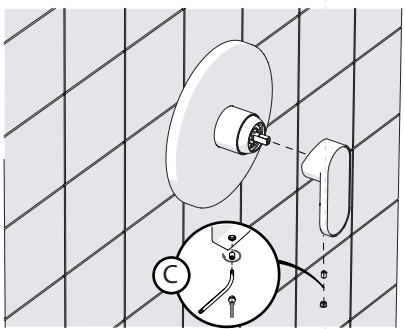
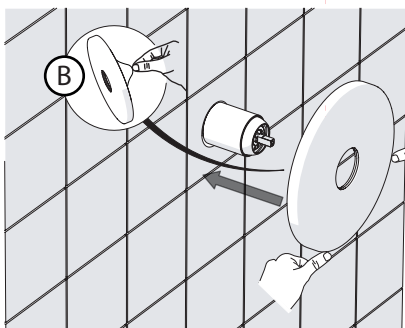



Dispositivo limitatore "dinamico"
della portata d'acqua "50%"
"Dynamic" flow rate restrictor "50%"

6

CLOSE ON 50% ON 100%



Posizione di chiusura
Closed position

Posizione di risparmio
acqua "50% portata"
Position of water
saving "50% capacity"

Posizione di apertura
totale 100% portata
100% Fully open flow

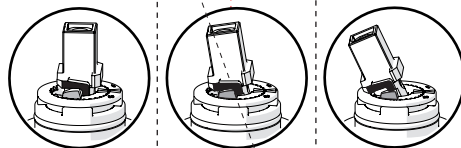

Per limitare la temperatura estrarre il limitatore
e riposizionarlo nella posizione che si desidera
Extract the limiter and put it in correct
position to limit temperature

8

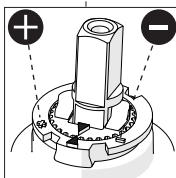
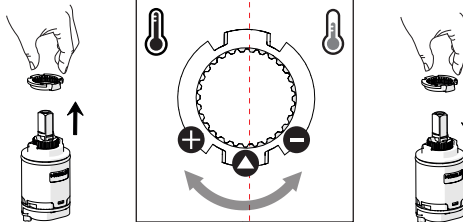

Nessuna limitazione
di temperatura
No limitation
of temperature

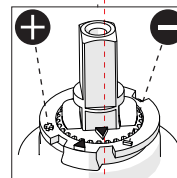

Limitazione parziale
di temperatura
Partial limitation
of temperature

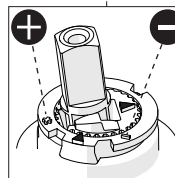

Massima limitazione
Solo acqua fredda
Maximum position
Only cold water



7

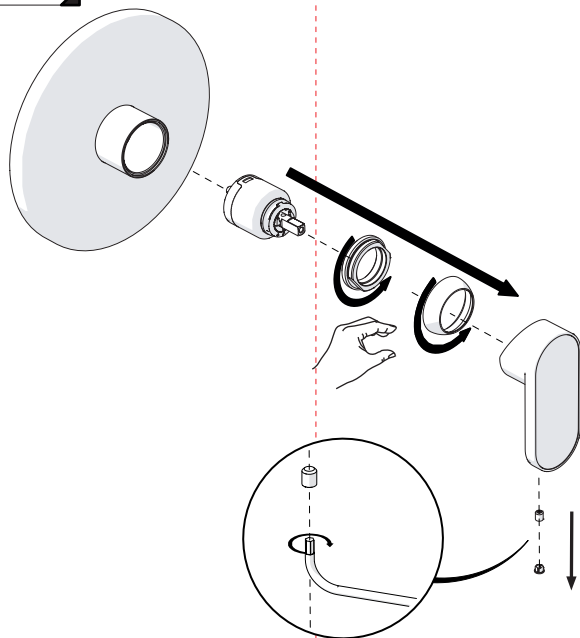

9

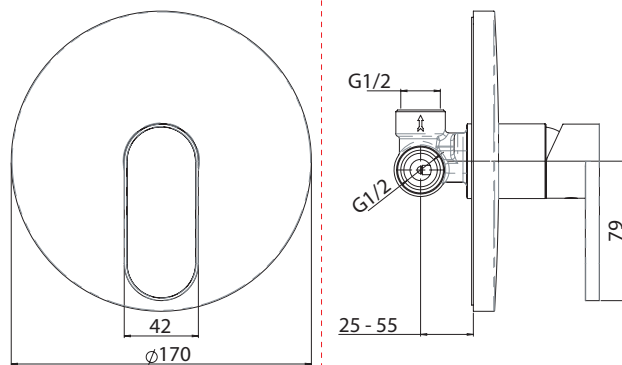

NOBILIS[®]
The Best Technology for Water

DRESS

DS106108

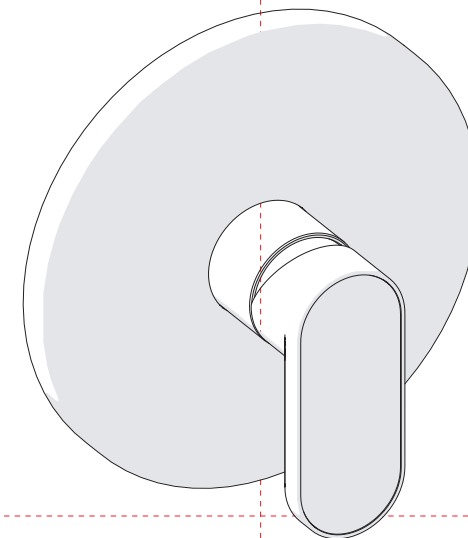

www.grupponobili.it

PRIMA DI INIZIARE / BEFORE STARTING

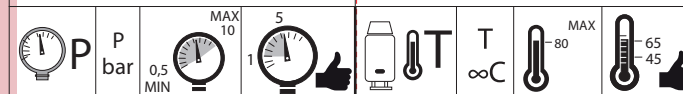

PULIZIA / CLEANING

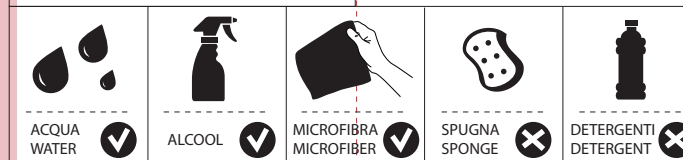

IISTRDS106108#---STD



REV0.03/2016