



SPECIFICATIES

Eengreeps-bassinkraan met watervalstraal

Chrome

Afvoer 1 1/4" push

Slangen rvs ø 3/8"

Debietbegrenzer met rem op 50%

Verpakking: 56,5 x 29 x 7,1 cm / 0,01163 m³ / 2,59 kg

CERTIFICERINGEN



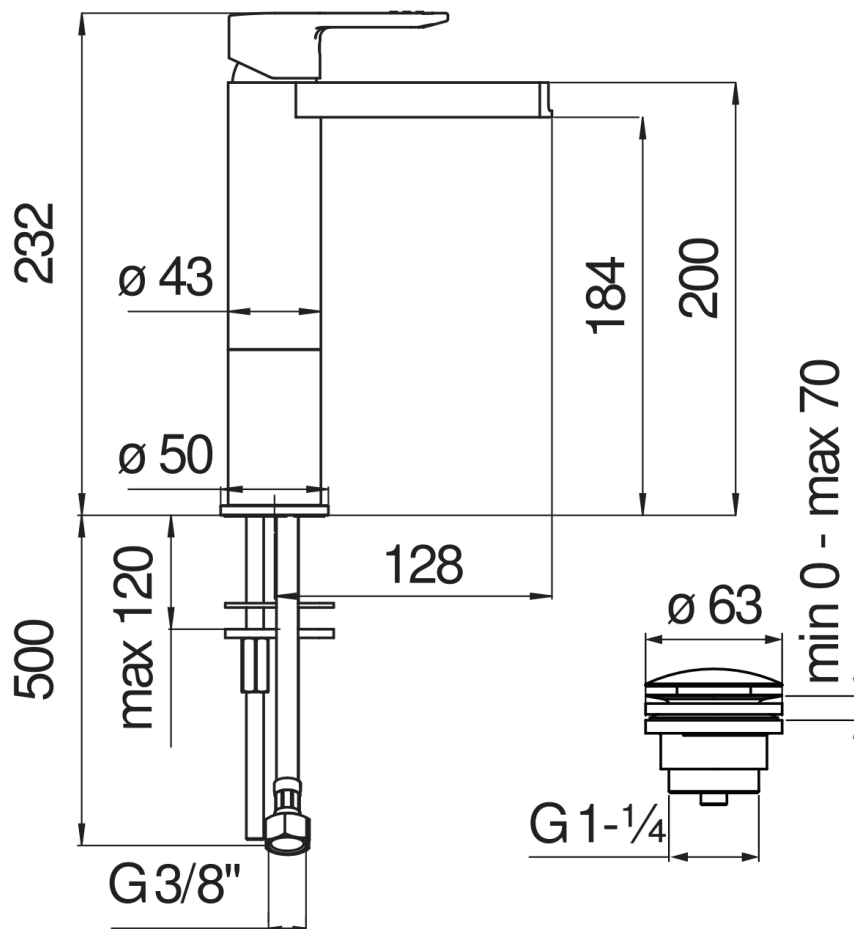

FLOW RATE DIAGRAM: HOT/COLD WATER

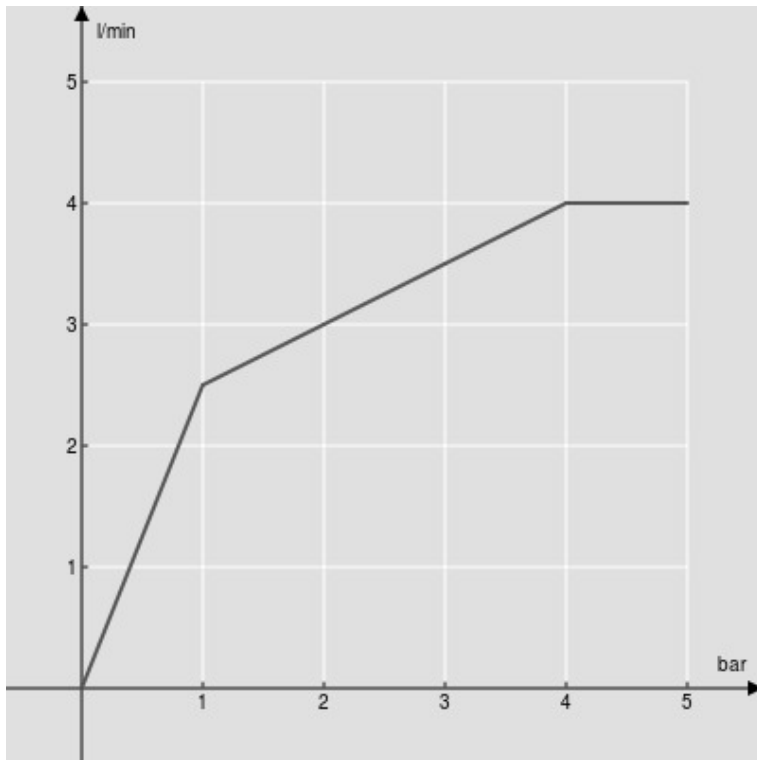

— Cascade spout

FLOW RATE DIAGRAM: MIXED WATER

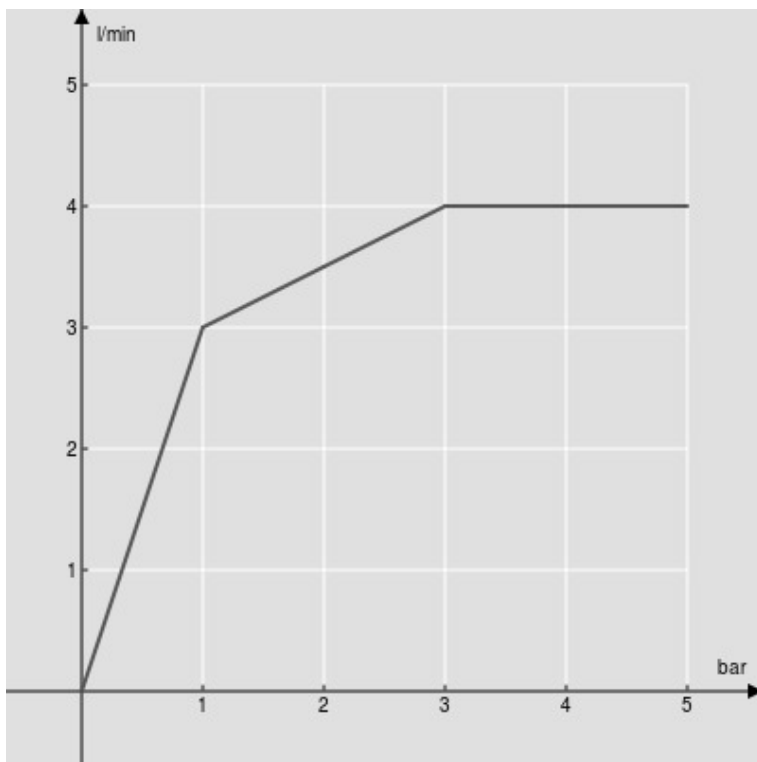

— Cascade spout