



SPECIFICATIES

Eengreepskraan opbouw met water- en energiebesparing

Chrome

Antikalkbeluchter M 24 x 1, debiet 5 l/min

Afvoer 1 1/4" push

Slangen rvs ø 3/8"

Energiespaarvoorziening met opening in koud water

Verpakking: 41,5 x 16 x 7,5 cm / 0,00498 m³ / 2,15 kg

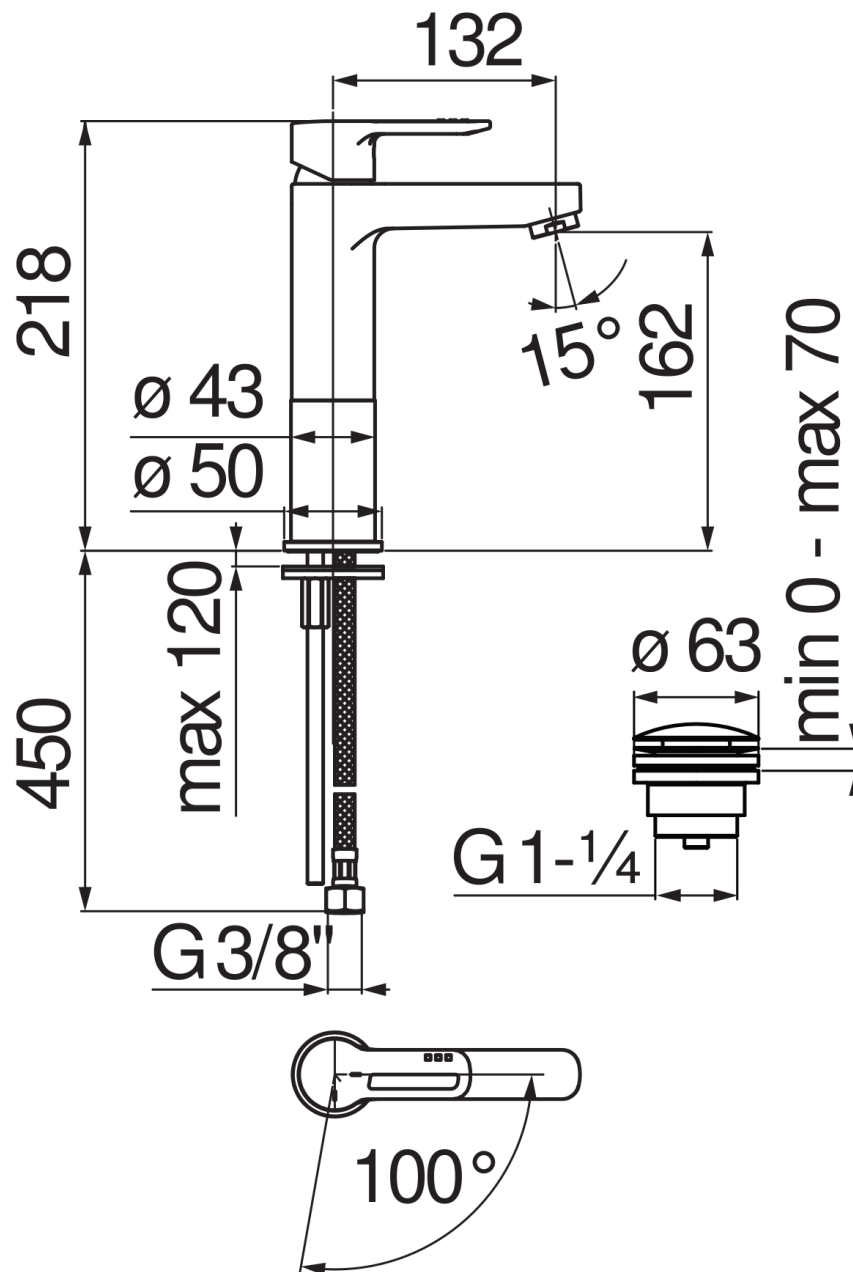

FLOW RATE DIAGRAM: HOT/COLD WATER

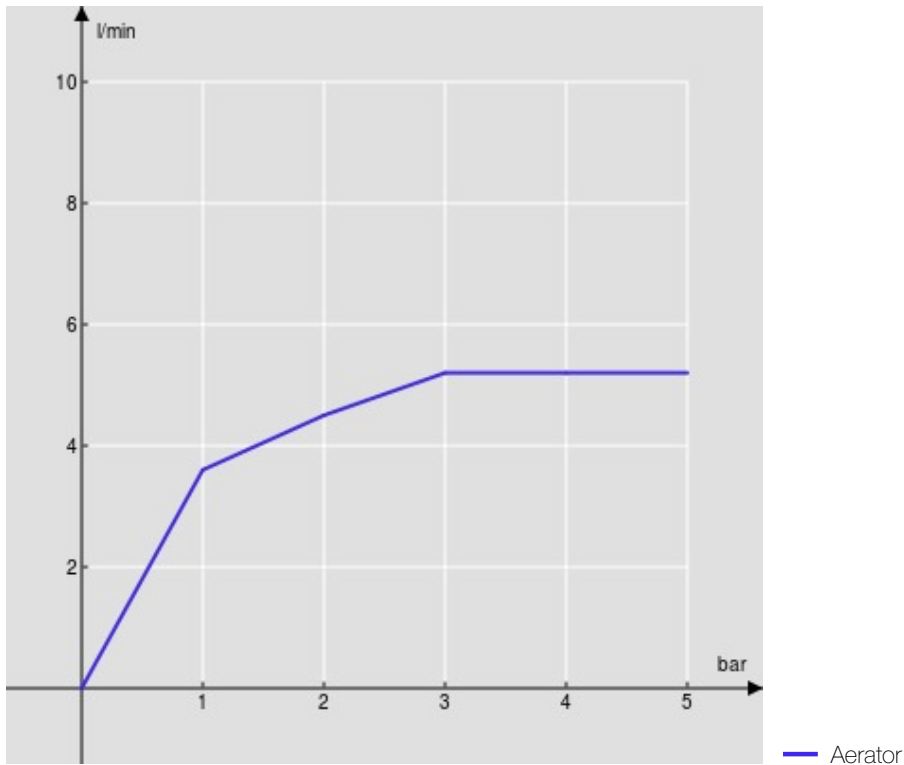

FLOW RATE DIAGRAM: MIXED WATER

