



SPECIFICATIES

Afwerkset muurmengkraan

Chrome

Anti-kalk beluchter M 24 x 1

Lengte uitloop 150 mm

Zonder afvoer

Debietbegrenzer met rem op 50%

Verpakking: 32 x 16,5 x 7 cm / 0,0037 m³ / 2,4 kg

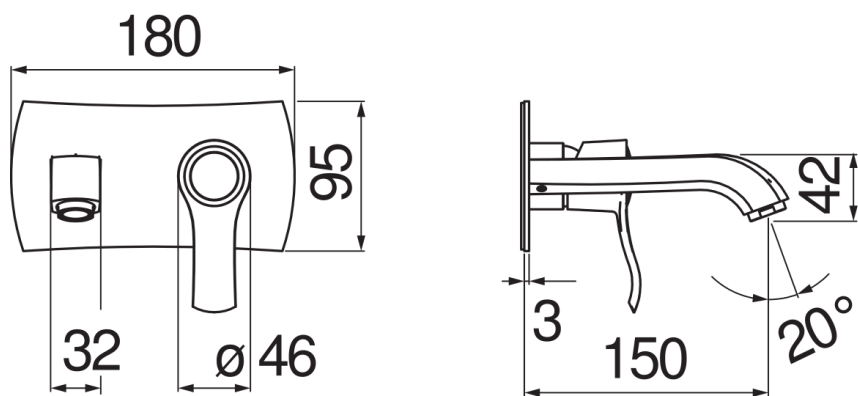

FLOW RATE DIAGRAM: HOT/COLD WATER

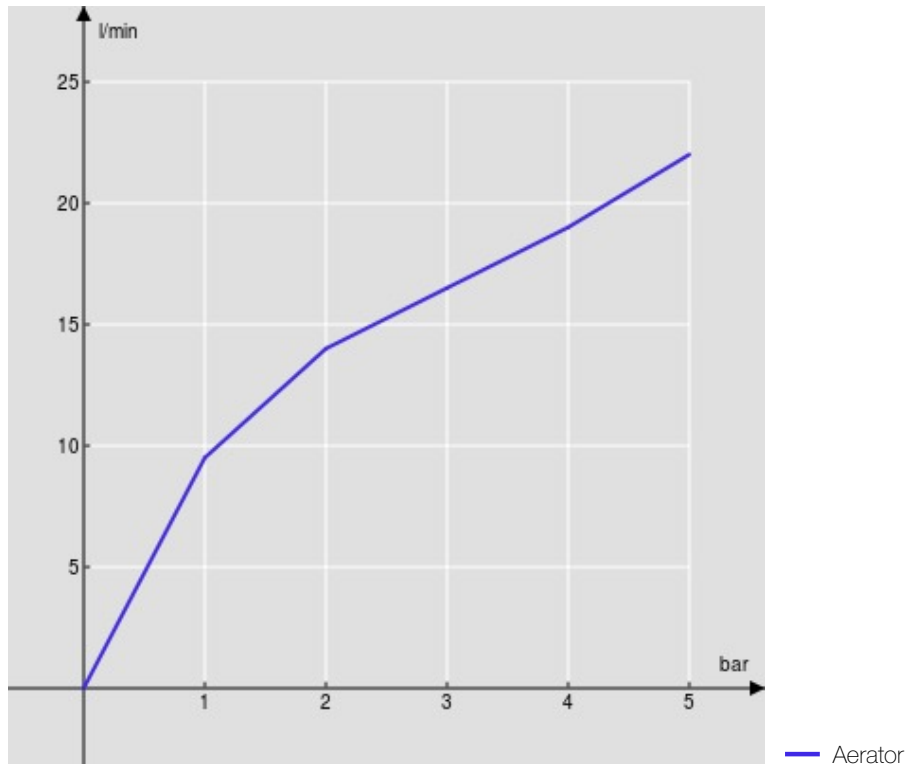

FLOW RATE DIAGRAM: MIXED WATER

