

SPECIFICATIES

Externe gedeelte eengreepskraan 2-wegs
Velvet black
Anti-kalk beluchter M 28 x 1
Omsteller met automatische terugkeer
Vaste handdouchehouder
Slang 150 cm en 1-straals handdouche
Debietbegrenzer met rem op 50%
Verpakking: 110,5 x 44 x 17,5 cm / 0,08509 m³ / 14 kg

CERTIFICERINGEN

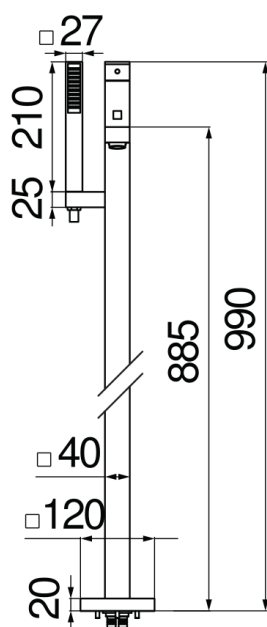

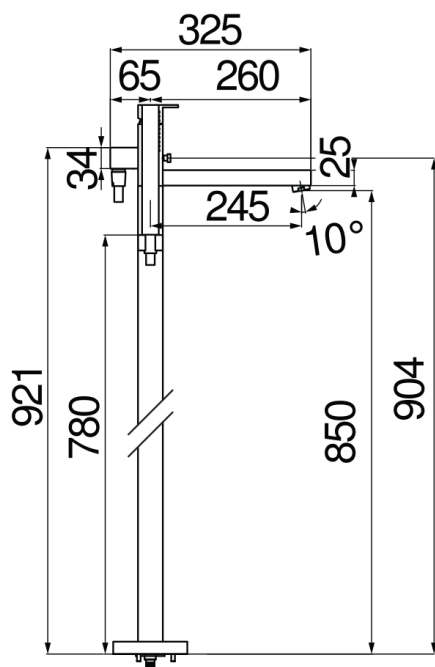

FLOW RATE DIAGRAM: HOT/COLD WATER

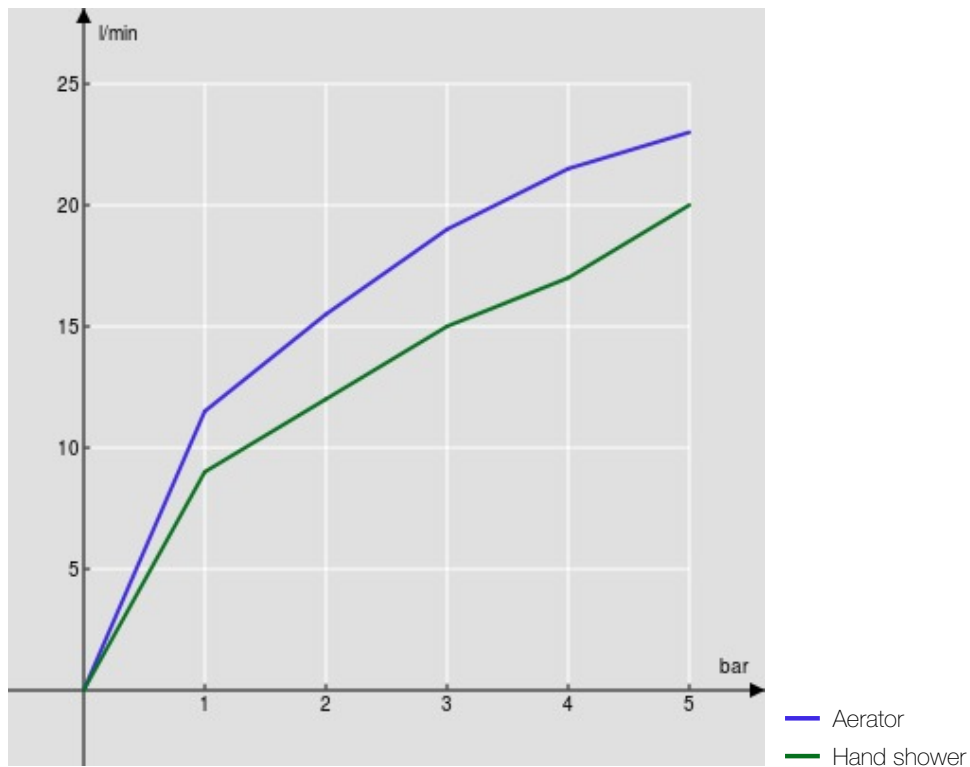

FLOW RATE DIAGRAM: MIXED WATER

