

NOBILIS

1

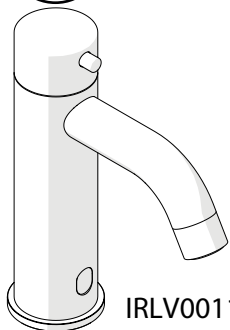

IRLV00118/3CR

2

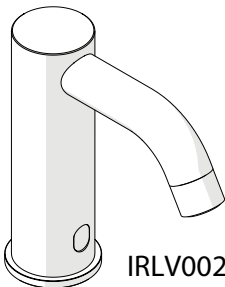

IRLV00236CR

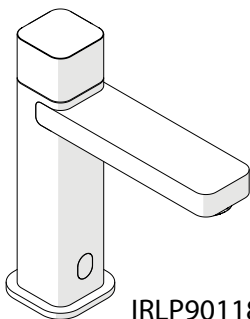

IRLP90118/3CR

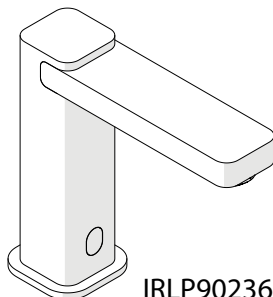

IRLP90236CR

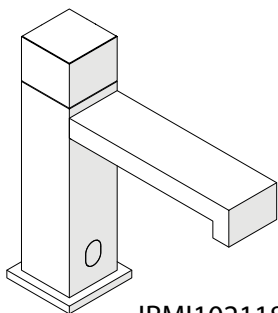

IRMI102118/3CR

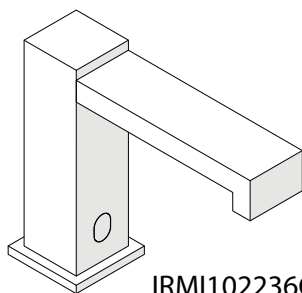

IRMI102236CR



Not included / Non incluso / Non Includo / Nie zawarty/ No incluido / Nao incluido

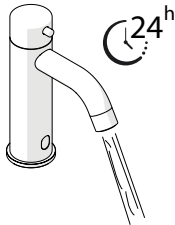
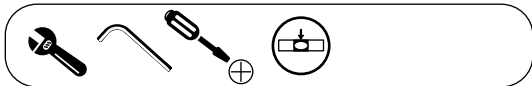

- I** Autoerogazione ogni 24 ore per 30 secondi
- GB** Self-opening every 24 hours for 30 seconds
- E** Auto-descarga cada 24 horas por 30 segundos
- F** Auto-approvisionnement toutes les 24 heures pendant 30 secondes



- I** Pacco batterie con custodia : litio CRP-2 6V
- 1 Funzionamento rubinetto 110.000 cicli
- 2 Funzionamento rubinetto 220.000 cicli

BATTERIA INCLUSA

- GB** Battery operated : lithium mod.CRP-2 6V
- 1 Faucet operation 110.000 cycles
- 2 Faucet operation 220.000 cycles

BATTERY INCLUDED

- E** Bateria litio CRP-2 con 6V
- 1 Funcionamiento del grifo 110.000 ciclos.
- 2 Funcionamiento del grifo 220.000 ciclos.

BATERIA INCLÚIDA

- F** Batteries au lithium CRP-2 6V
- 1 Fonctionnement du robinet 110.000 cycles
- 2 Fonctionnement du robinet 220.000 cycles

BATTERIE INCLUS



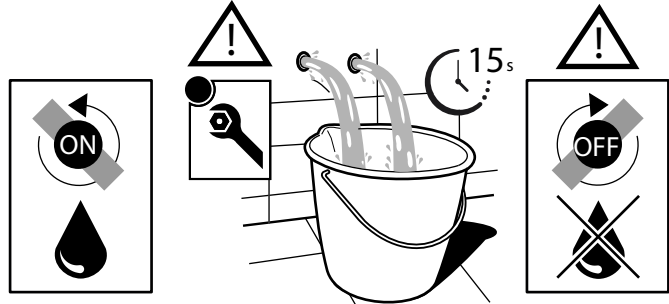
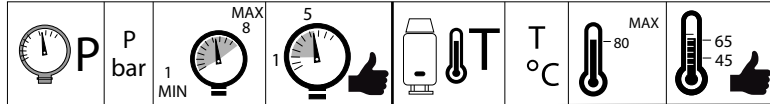

T < 5°C

- I** Non esporre il rubinetto a temperature inferiori a 5°C (per esempio durante il periodo invernale): in caso contrario provvedere per tempo allo svuotamento dello stesso da ogni residuo d'acqua.
- GB** Do not expose the tap to temperatures lower than 5°C (for example during winter time); otherwise arrange on time for the drainage of the same from any water residual.
- E** No exponer el grifo a temperaturas inferiores a 5°C (por ejemplo en invierno): de lo contrario proveer pronto a vaciarlo de todos los residuos de agua.
- F** Ne pas exposer le robinet à températures inférieures à 5°C (pour exemple dans la période hivernale): dans le cas contraire effectuer pour temps le vidange complet du robinet .

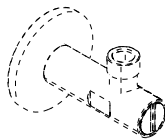
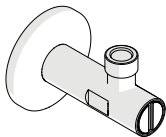



NON INCLUSO
NOT INCLUDED
NO INCLUIDO
NON INCLUS

-   • Alimentare il rubinetto sottolavabo con **FILTRO** ispezionabile: la presenza di impurità può causare malfunzionamenti. In caso di acqua particolarmente ricca di minerali provvedere ad installare un addolcitore.



ATTENZIONE: La mancata installazione del **rubinetto sottolavabo con FILTRO ispezionabile** può gravemente compromettere la funzionalità dell'elettrovalvola e fa automaticamente decadere la **garanzia** del prodotto.

- In caso di chiusura temporanea dell'impianto (per interventi di manutenzione o chiusure stagionali) prima di alimentare nuovamente la linea effettuare uno spurgo della stessa a monte del rubinetto.



- Raccomandiamo di installare un rubinetto di intercettazione sulla linea di alimentazione per facilitare gli interventi di manutenzione.

Consigliato in caso di previsione di fermo impianto per un periodo tempo elevato (alcuni mesi) per spurgare l'acqua sporca.



- In caso di alimentazione con acqua pre-miscelata consigliamo l'utilizzo di un miscelatore termostatico di linea.



- Installer faucet with valve with inspectable FILTER must be made to ensure the water quality (including limescale) when installing this product; the presence of impurities may damage the solenoid valve.



ATTENTION : failure to faucet installation with **valve with inspectable FILTER** on the supply pipe can damage the solenoid valve and automatically invalidate the **warranty** of the product.

- In case of temporary closing of the plant, purge the up-streaming water supply, before reopening the plant.



- We suggest to install check valves on the water supply lines, to help eventual maintenance operations.

Recommended in case of forecast of plant stop for a period of time high (a few months) to purge dirty water.



- In case of supply with pre-mixed water, we suggest the use of a thermostatic mixing valve.

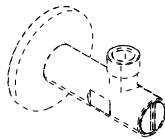
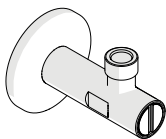

NON INCLUSO
NOT INCLUDED
NO INCLUIDO
NON INCLUS



- Alimentar el grifo con válvula con **FILTRO** inspeccionable : la presencia de impurezas puede causar el malo funcionamiento de la electroválvula; en caso de agua particularmente rica en minerales, proveer a la instalación de un ablandador de agua.



ATENCIÓN: No instalar el válvula con FILTRO inspeccionable comprometer en serio el funcionamiento de la electroválvula y hace decaer la garantía del producto.

- En caso de cierre temporal de la instalación (por intervenciones de mantenimiento o cierres estacionales) antes de alimentar nuevamente la línea, purgar las tuberías por arriba del grifo - un cuerpo extraño en la alimentación podría dañar gravemente la electroválvula.



- Recomendamos de instalar una llave de paso en la línea de alimentación, para facilitar las intervenciones de mantenimiento. **Recomendado en caso de pronóstico de parada de planta por un período de tiempo alto (unos pocos meses) para purgar el agua sucia.**



- En caso de alimentación con agua pre-mezclada aconsejamos la utilización de un mezclador termostático.



- Alimenter le robinet avec vanne avec **FILTRO** inspectable: la présence d'impuretés peut causer le mauvais fonctionnement du robinet; en cas d'eau particulièrement riche de minéraux il faut installer un adoucisseur.



ATTENTION : la non installation des vanne avec FILTRO inspectable avec joints peut endommager gravement la fonctionnalité de l'électrovanne et par conséquence la garantie du produit ne sera pas accordée.

- En cas d'arrêts temporaires de l'installation (pour interventions d'entretien ou pour des arrêts saisonniers), avant d'alimenter de nouveau le circuit il faut faire un vidange de celui-ci en amont du robinet, un corps étranger dans l'alimentation pourrait endommager gravement l'électrovanne.



- Nous conseillons d'installer des robinet d'arrêt sur la ligne d'utiliser un mitigeur thermostatique sur réseau. **Recommandé en cas de prévision d'arrêt de l'usine pour une période donnée élevé (quelques mois) pour purger l'eau sale.**



- En cas d'alimentation avec eau pré-mitigée nous recommandons d'utiliser un mitigeur thermostatique sur réseau.

1

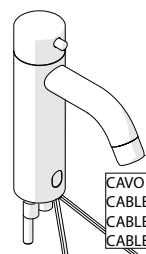
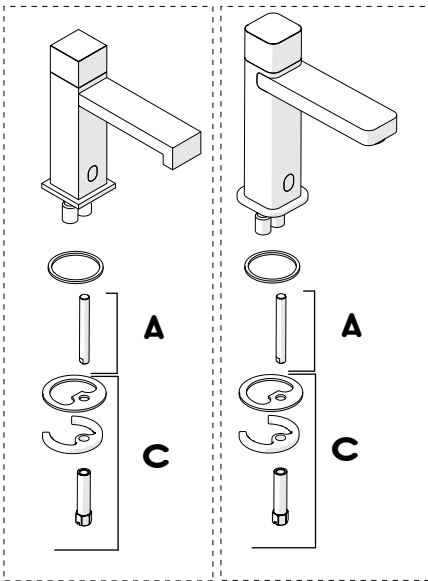
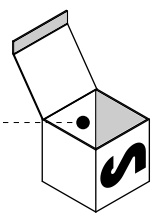

CAVO PER ELETTROVALVOLA
CABLE FOR SOLENOID VALVE
CABLE PARA VALVULA SOLENOIDE
CABLE POUR ELECTROVANNE

CAVO PER BATTERIA
CABLE FOR BATTERY
CABLE PARA BATERIA
CABLE POUR BATTERIE

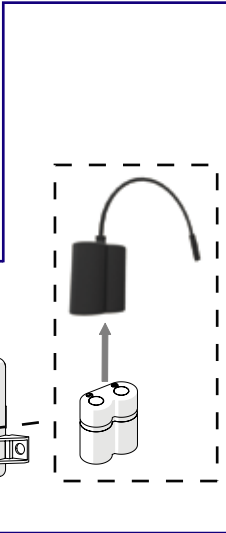
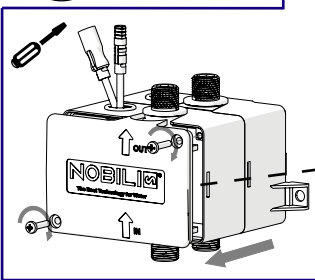
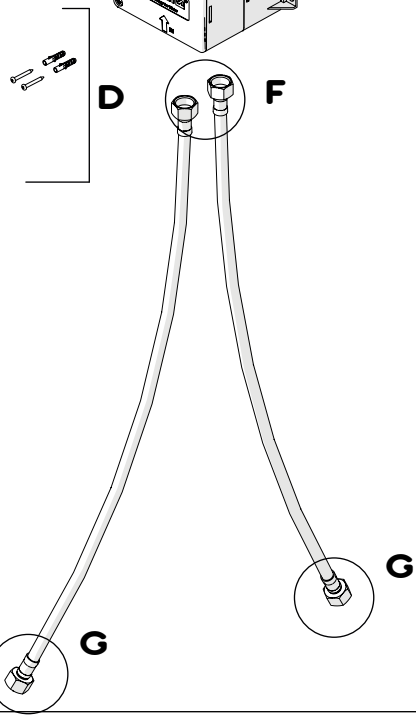
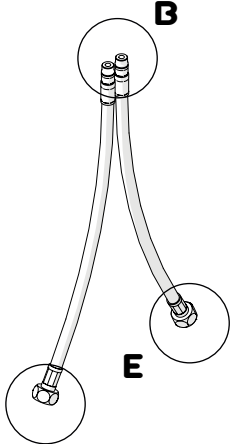
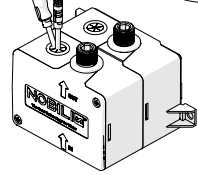
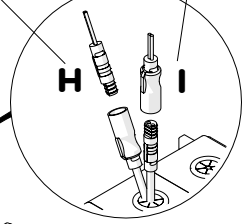

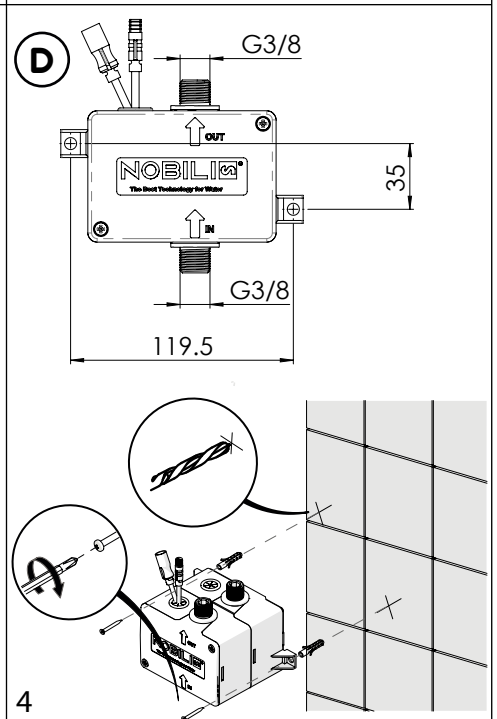
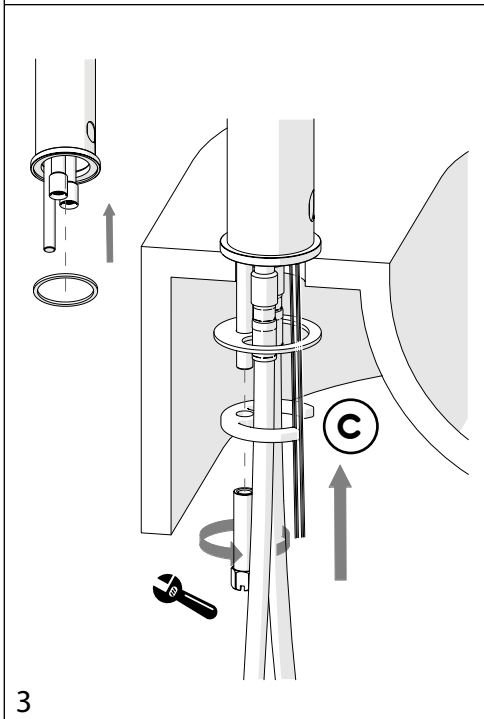
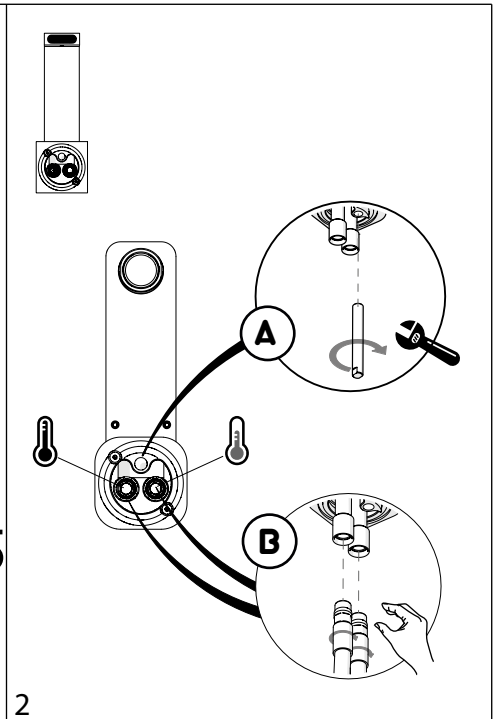
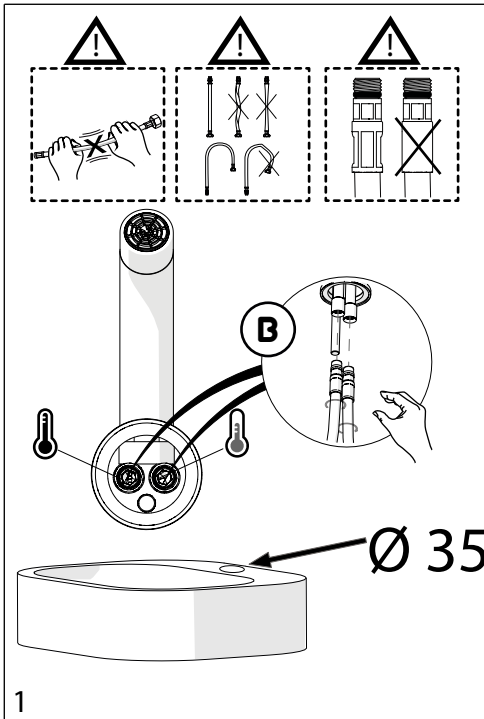

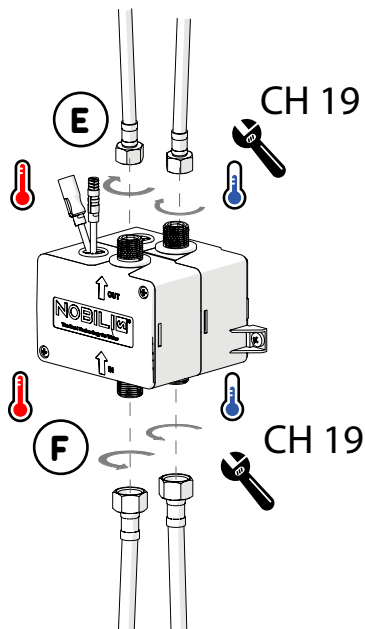
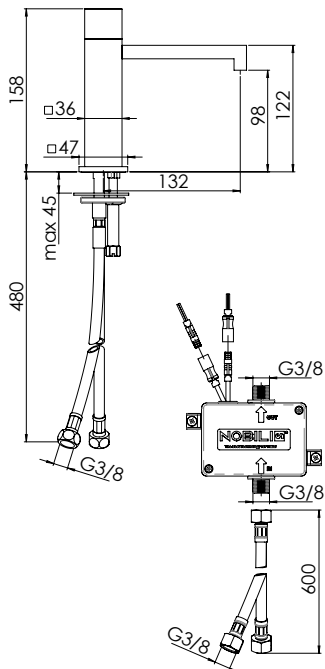
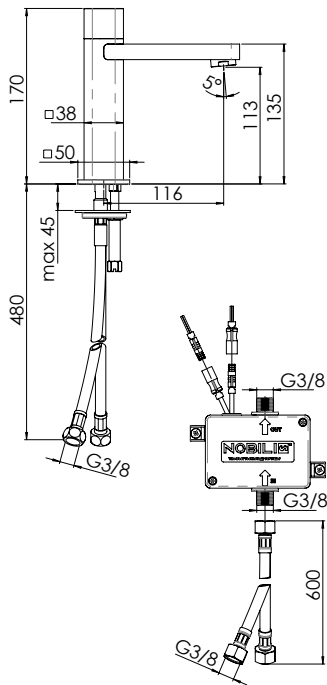
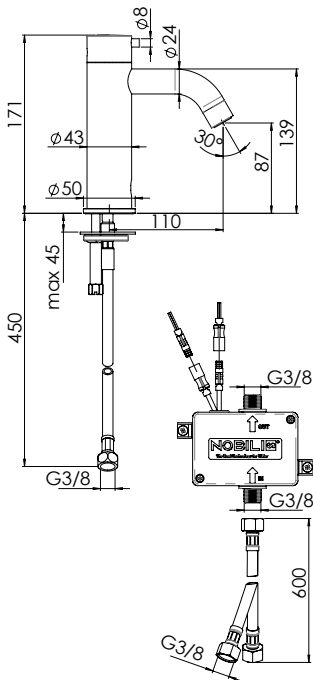

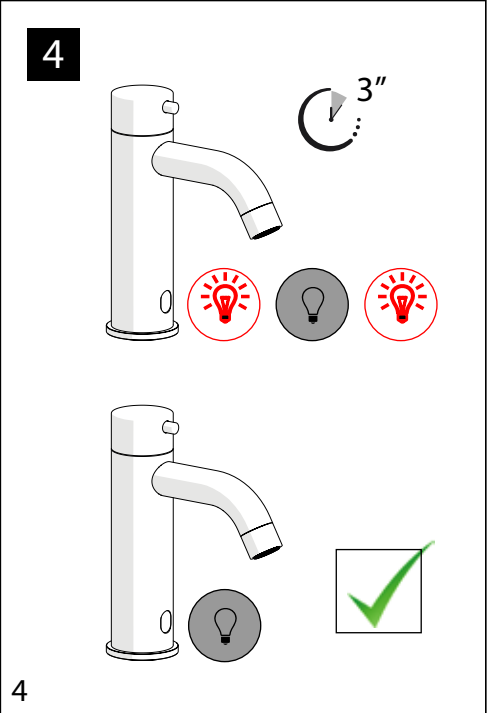
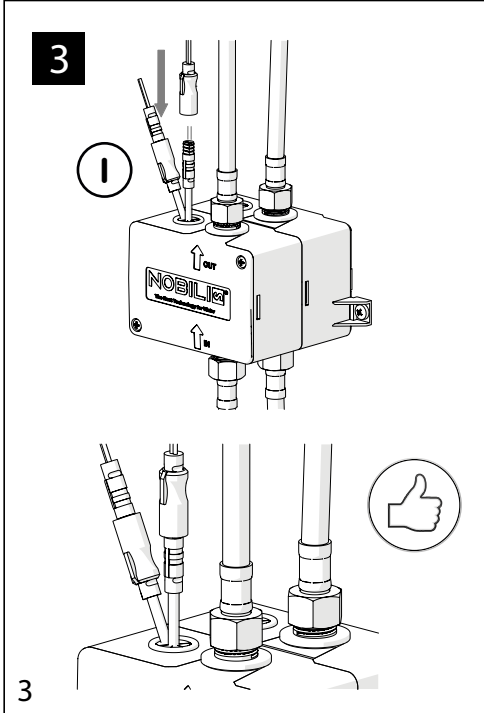
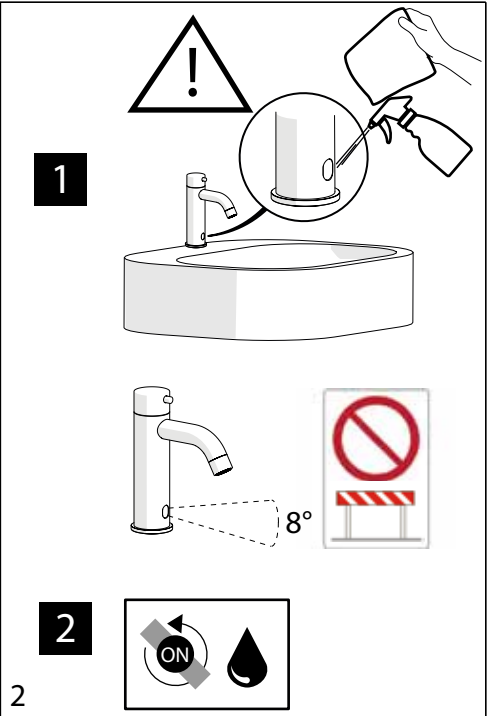
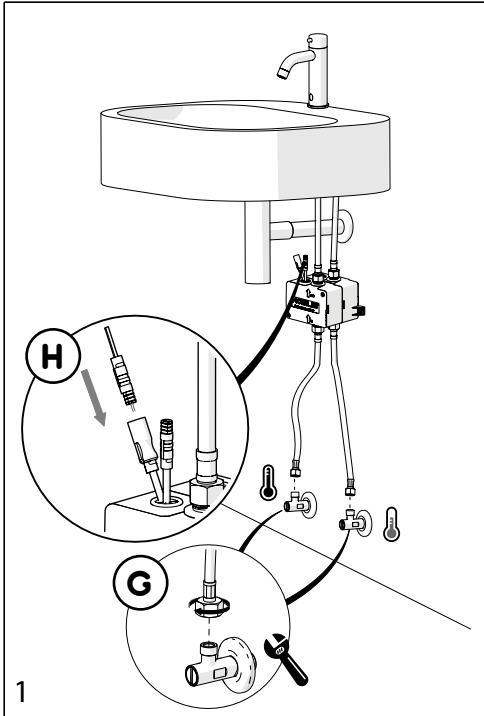

2

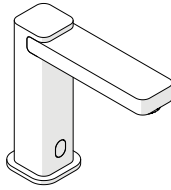
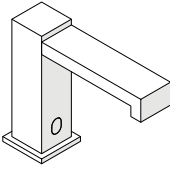

A

C



A

C

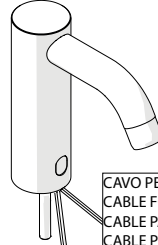

CAVO PER ELETTROVALVOLA
CABLE FOR SOLENOID VALVE
CABLE PARA VALVULA SOLENOIDE
CABLE POUR ELECTROVANNE

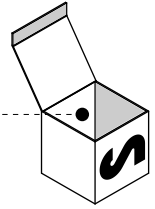

CAVO PER BATTERIA
CABLE FOR BATTERY
CABLE PARA BATERIA
CABLE POUR BATTERIE

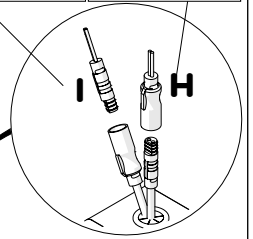

C

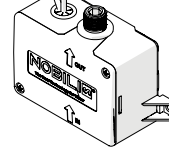

D

B

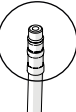

E



F



G

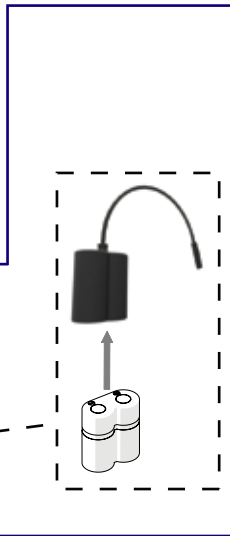
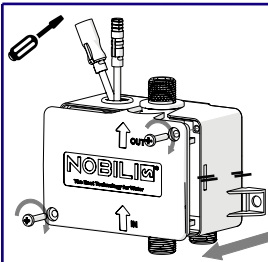

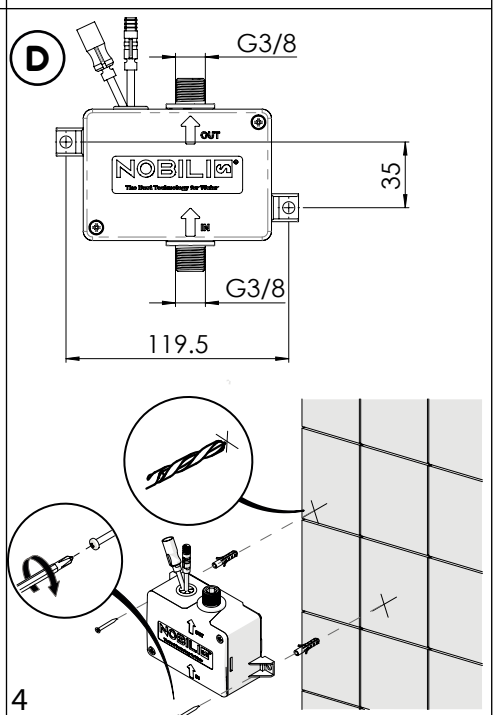
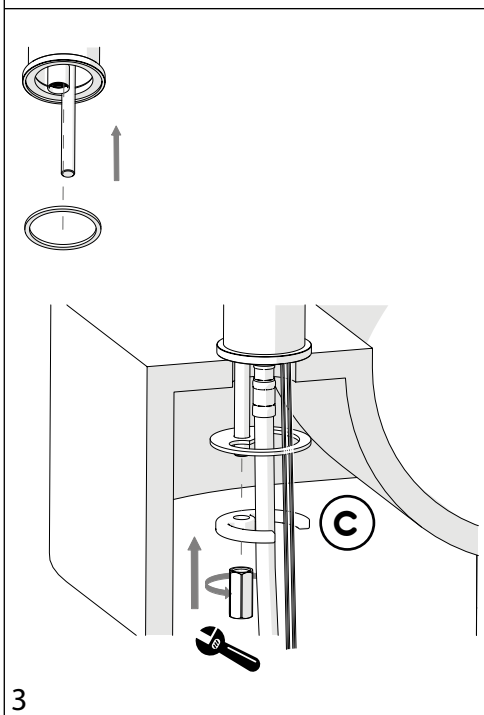
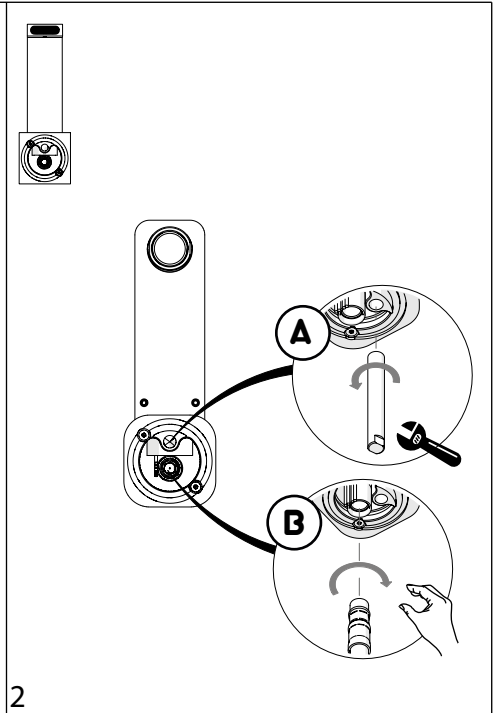
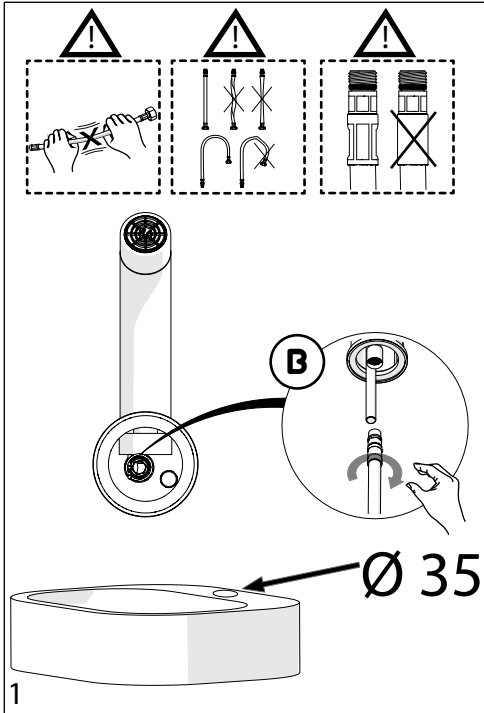

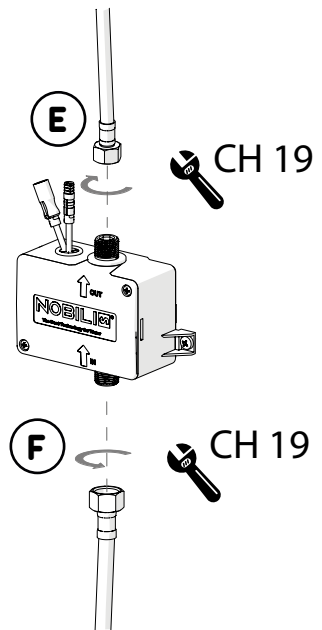
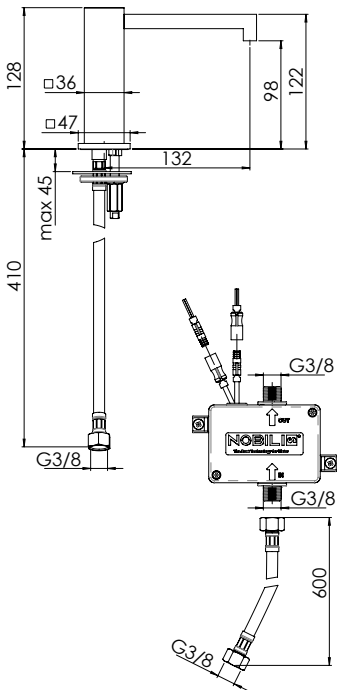
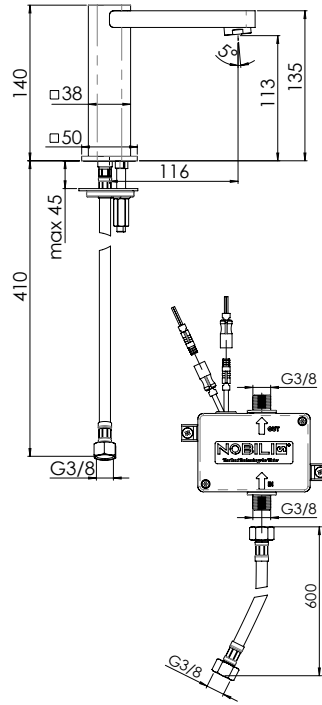
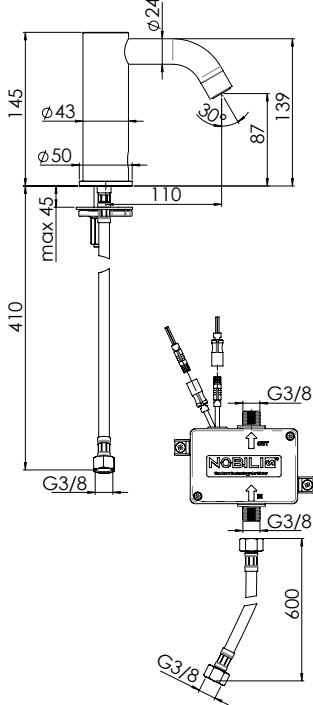

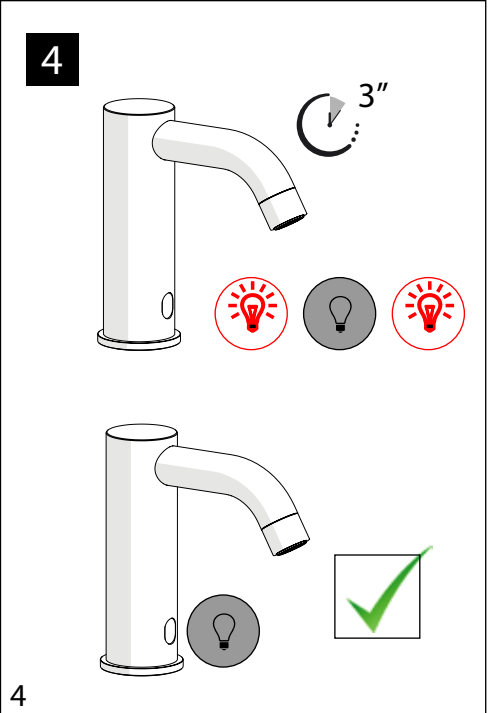
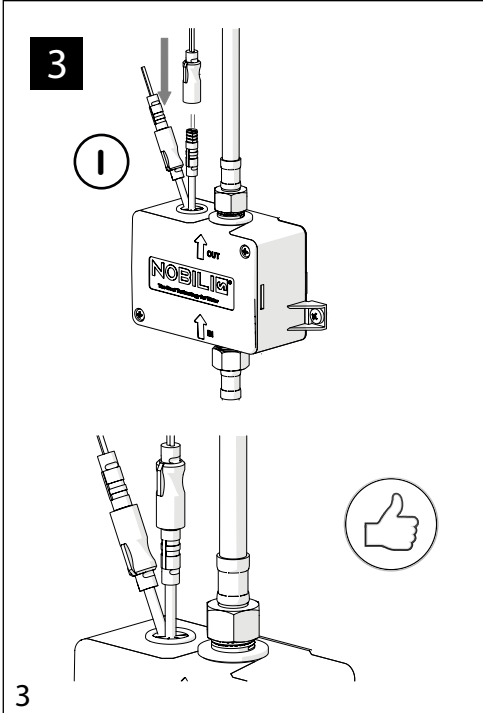
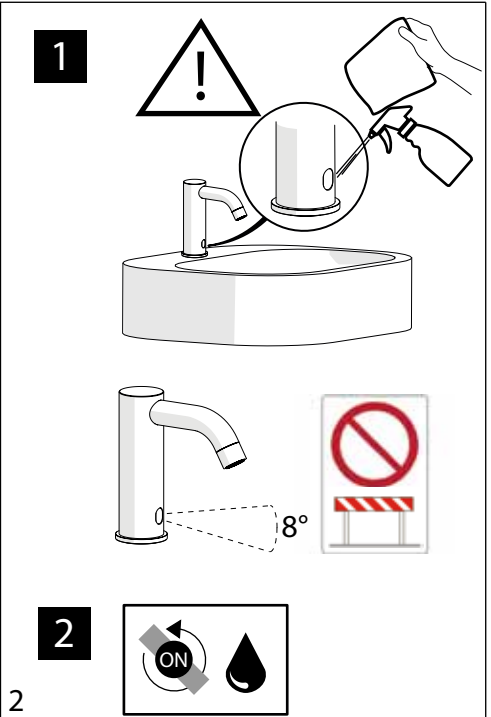
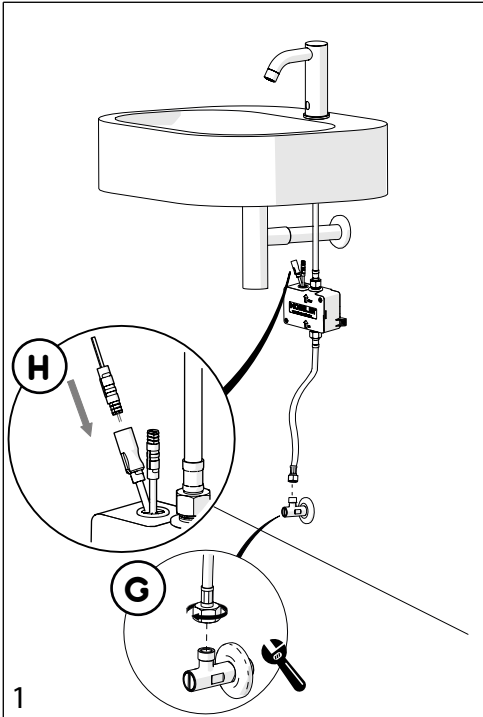

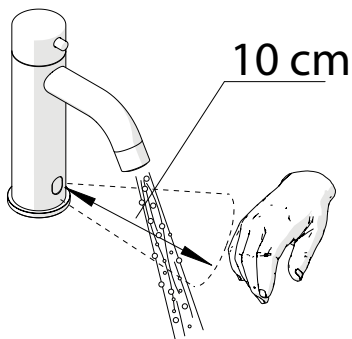

La distanza di erogazione dell'acqua dal sensore è pre-regolata in fabbrica: 10 cm



The distance to dispense water from the sensor is pre-settled: 10 cm



La distancia para dispensar agua desde el sensor está regulada de forma estándar: 10 cm



La distance de alimentation en eau du capteur est réglée par défaut: 10 cm

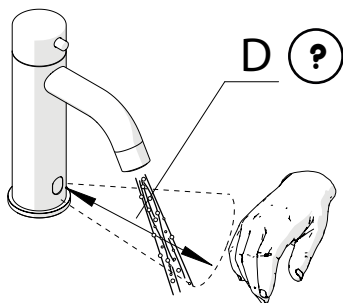

In caso di funzionamenti anomali del sensore:
- erogazioni non richieste
- chiusure ritardate fino a 1 minuto

la distanza di rilevamento si può REGOLARE:

1. Scollegare il connettore di alimentazione (I) ;
2. Attendere 10 secondi e ricollegarlo, il led rosso lampeggia ;



In case of anomalous functioning of the sensor
- unmotivated water flows
- delayed closures up to 1 minute

you can REGULATE the survey distance:

1. Unplug the connector of power supply (I) ;
2. Wait for 10 seconds and plug it again, the red led blinks ;



En caso de funcionamiento anómalo del sensor
- no se requieren suministros de agua
- Cierres retrasados hasta 1 minuto

puede REGULARLO la distancia de estudio:

1. Desconectar el cable de alimentación (I) ;
2. Esperar durante 10 segundos y volver a conectarlo, el led rojo relampaguea ;





En cas de mal fonctionnement du capteur
- écoulements pas demandés
- retardées jusqu'à 1 minute

la distance de enquête peut être ajustée:

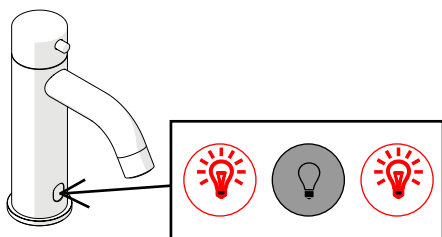
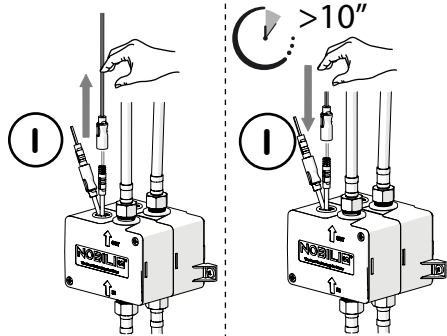
1. Débranchez le connecteur (I) ;
2. Attendre 10 seconds et re connecter., la LED rouge clignote ;

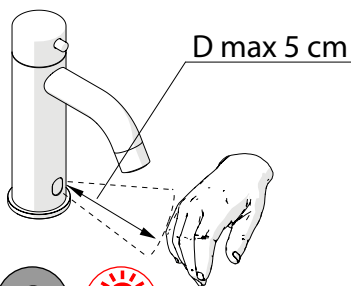





 **I**
 3. Posizionare immediatamente una mano davanti al sensore (max 5 cm di distanza) mentre il led rosso lampeggia (se si spegne è necessario togliere nuovamente l'alimentazione e ripetere l'operazione);

 **GB**
 3. When the red led blinks (if it switches off, it is necessary to remove the power supply again and repeat the operation), put immediately one hand in front of the sensor (at a distance of max. 5 cm);

 **E**
 3. Posicionar inmediatamente una mano delante del sensor (max 5 cm de distancia) mientras el led rojo relampaguea (si se apaga, es necesario volver a quitar la tensión eléctrica y repetir la operación).

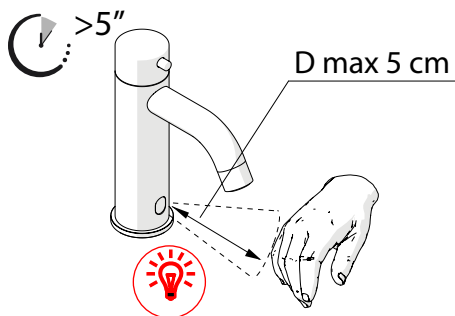
 **F**
 3. Positionner immédiatement une main devant le capteur (max 5 cm. de distance) pendant que le led rouge clignote (s'il s'éteint il est nécessaire d'enlever de nouveau l'alimentation et de répéter l'opération).



 **I**
 4. Attendere fino a quando il led rosso s'illumina in modo permanente e spostare la mano alla distanza desiderata;

 **GB**
 4. When the red led lights up permanently, place the hand at the desired distance;

 **E**
 4. Esperar hasta que el led rojo se encienda de forma continua y posicionar la mano a la distancia deseada.

 **F**
 4. Attendre jusqu'à ce que le led rouge s'allume d'une manière permanente et déplacer la main à la distance désirée.

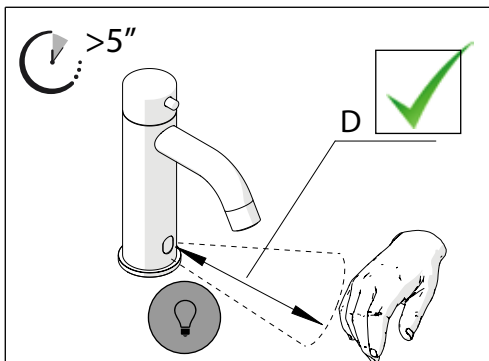

5. Attendere che il led si spenga prima di togliere la mano; a questo punto la nuova distanza è stata memorizzata. La nuova impostazione verrà mantenuta anche in caso di cambio batteria.



5. Wait for the switching off of the led before taking out the hand; at this point the new distance is recorded. The new setting will be kept also in case of battery replacement.

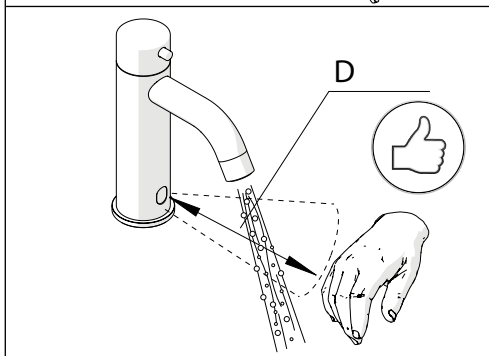

5. Esperar que el led se apague antes de quitar la mano; en este momento la nueva distancia de detección se ha memorizado. Esta nueva impostación será mantenida también en caso de las baterías.



5. Attendre que le led s'éteint avant d'enlever la main; à ce moment la nouvelle distance a été mémorisée. Ce nouveau réglage sera maintenu aussi en cas d'interruption de de changement de la batterie.

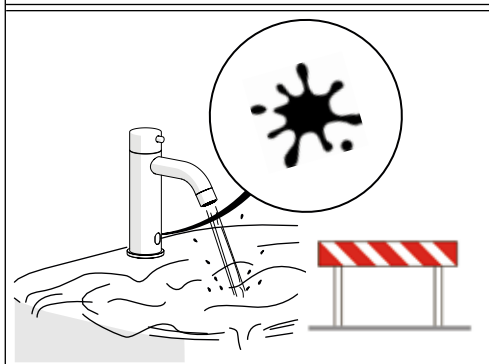

Per evitare l'allagamento dei locali in seguito ad atti vandalici o non curanza (oggetto dimenticato davanti al sensore o sensore sporco), il rubinetto è dotato di un dispositivo di sicurezza che interrompe il flusso dell'acqua dopo 1 minuto. Una volta rimosso l'ostacolo (o pulito il sensore) il rubinetto riprende la propria funzionalità.



To prevent flooding of locals following acts of vandalism or carelessness (an object left in front of the sensor or dirty sensor), the tap has a safety device that interrupts the water flow after about 1 minute. Once the object has been removed (or the sensor has been cleaned), the tap starts working again.



Para evitar la inundación de los locales luego a actos vandálicos o a negligencia (objeto olvidado delante del sensor o sensor sucio), el grifo está equipado con un dispositivo de seguridad que interrumpe el flujo del agua después de 1 minuto. Una vez quitado el obstáculo (o limpiado el sensor) el grifo vuelve a funcionar.



Pour éviter l'inondation des locaux suite à des actes de vandalisme ou insouciance (objet oublié devant le capteur ou capteur sale), le robinet est doté d'un dispositif de sécurité qui interrompt l'écoulement de l'eau après 1 minute. Une fois éliminé l'obstacle ou nettoyé e capteur, le robinet reprend sa propre fonctionnalité.

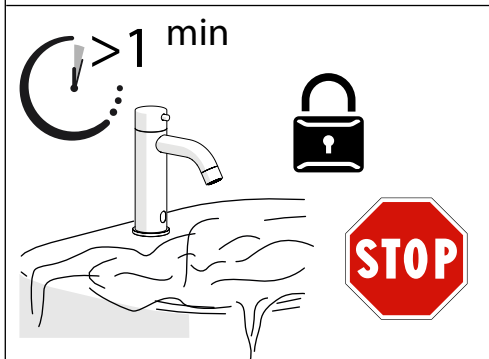

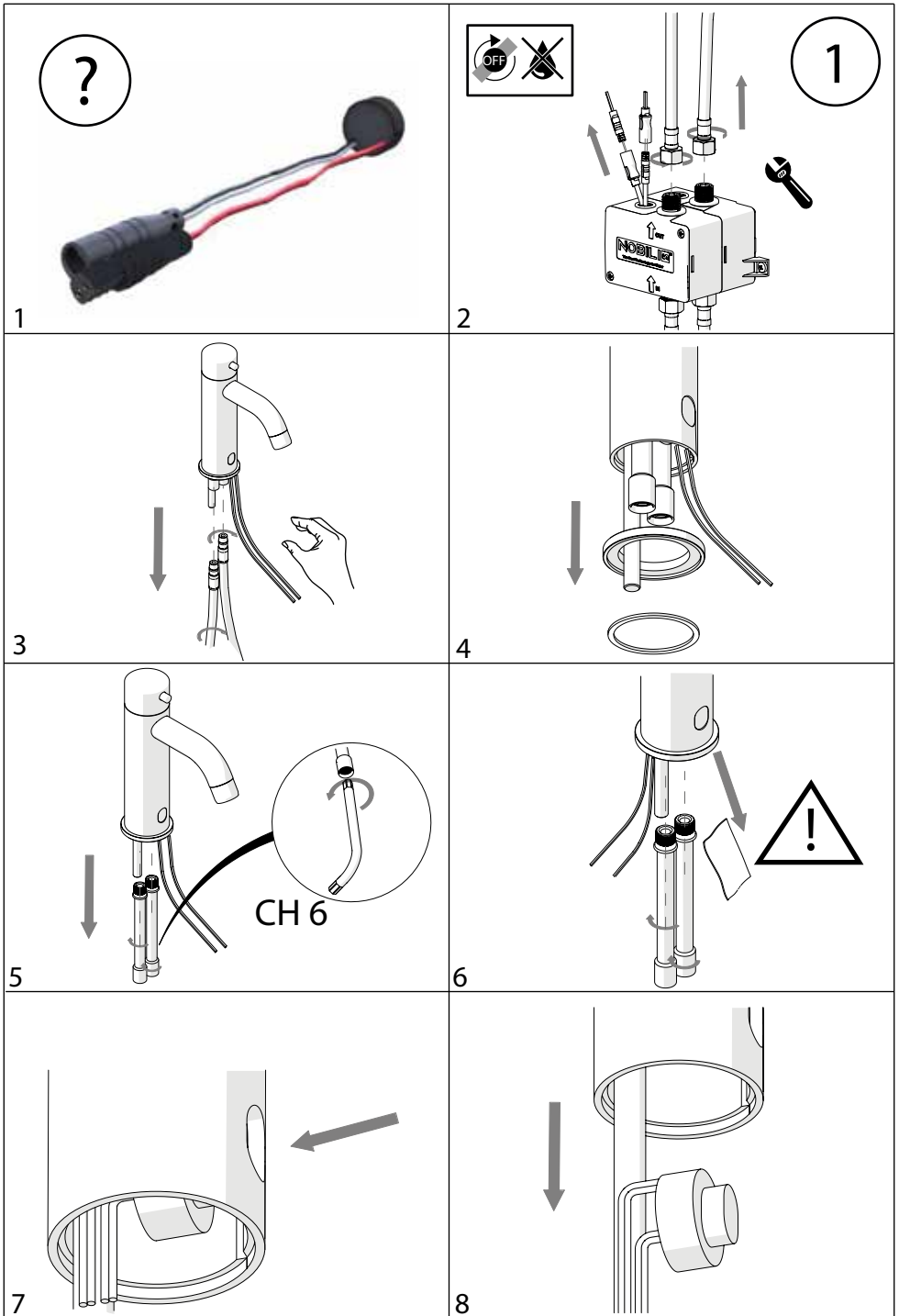

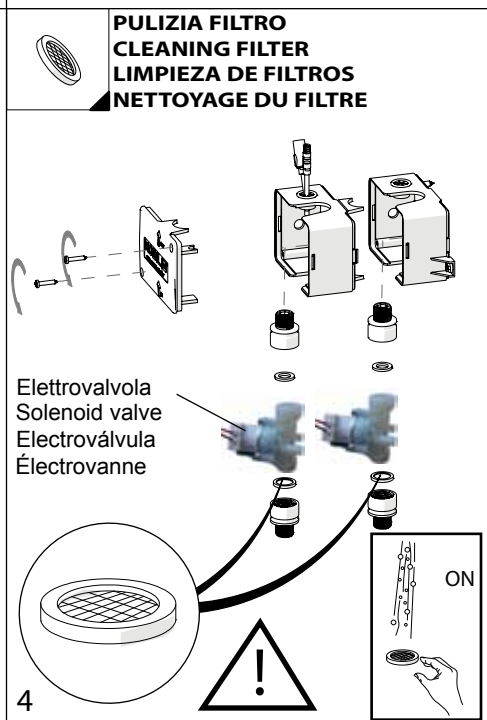
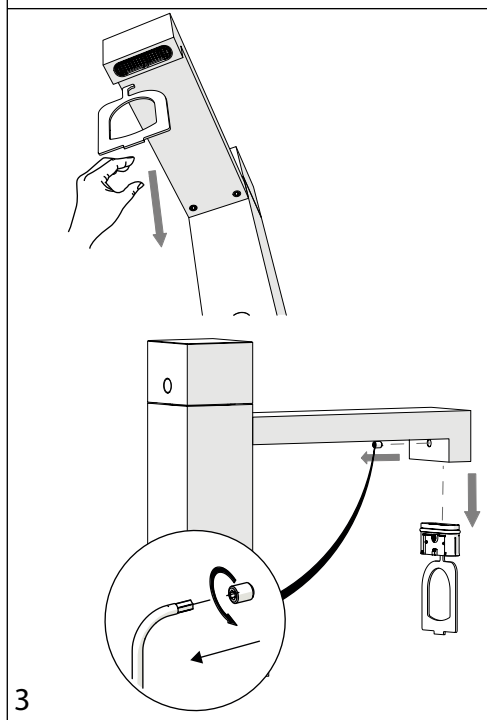
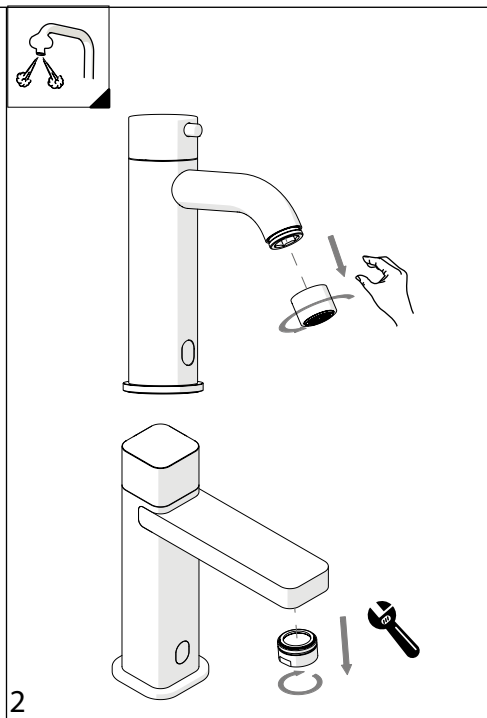
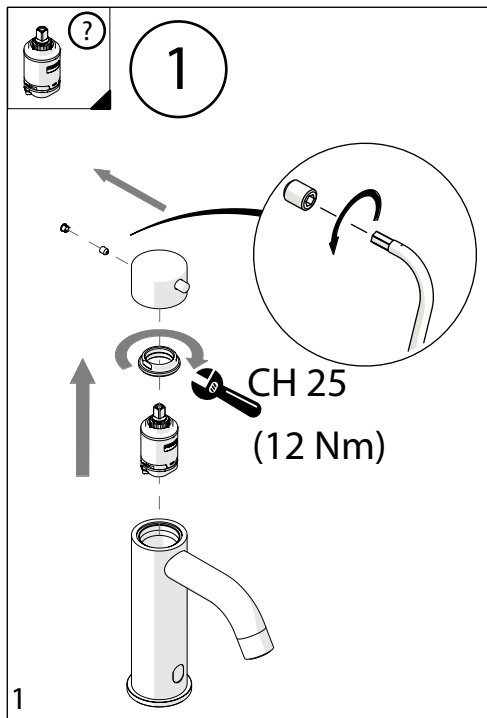

PULIZIA / CLEANING / LIMPIEZA / NETTOYAGE

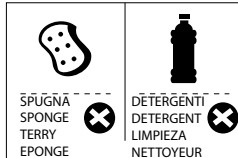
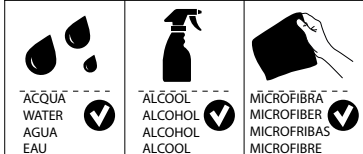

1

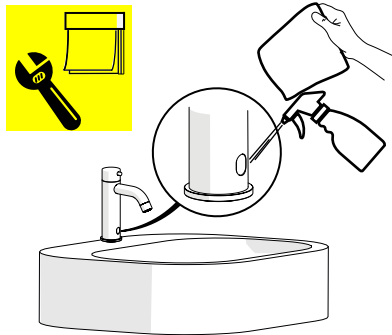

2



**PULIZIA FILTRO / LIMPIEZA DE FILTROS
CLEANING FILTER / NETTOYAGE DU FILTRE**

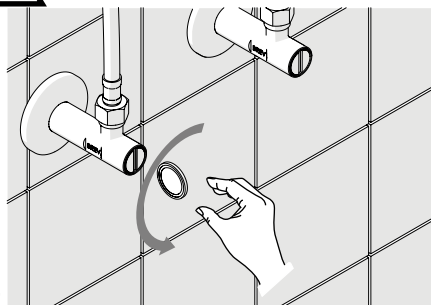

3

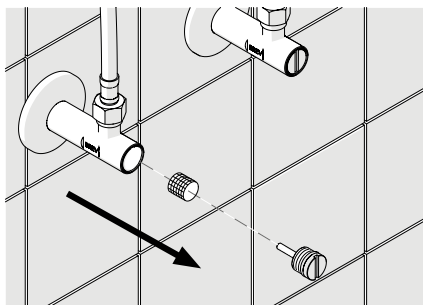

4

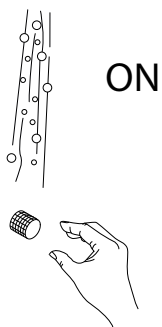

5

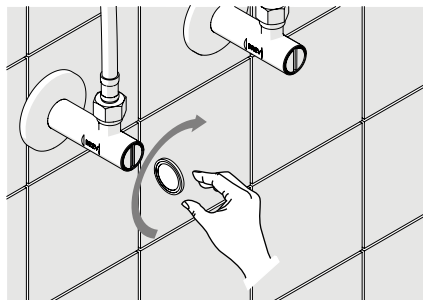

6

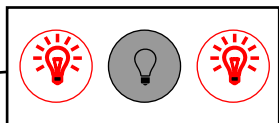
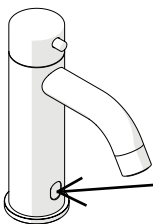

7

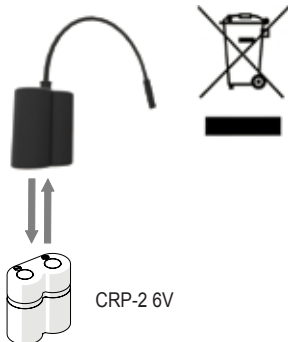

8

**GUASTO****CAUSA****SOLUZIONI**

1 2

L'acqua non esce

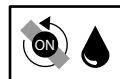
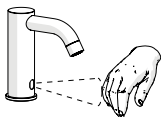

Batteria esaurita (il led lampeggia continuamente)

Sostituire la batteria

Problema elettrico

- Scollegare e ricollegare la batteria
- Verificare collegamento connettori e l'integrità del cavo
- Sensore danneggiato: richiedere ☎

I filtri di ingresso sono intasati

Pulire i filtri

Elettrovalvola bloccata

Richiedere ☎

L'acqua rimane aperta per 1 minuto (senza oggetti di fronte al sensore)

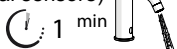

Sensore sporco

Pulire il sensore

Riflessi di luce sul sensore

- Eliminare le fonti del riflesso
- Variare la distanza di rilevamento

Problema elettrico

Scollegare e ricollegare la batteria (RESET)

L'acqua rimane aperta oltre 1 min

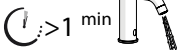

Elettrovalvola bloccata / sensore danneggiato

Richiedere ☎

Il rubinetto si apre/chiude autonomamente senza ragione

Sono trascorse 24 ore dall'ultima erogazione

Funzionamento corretto ✓

Riflessi di luce sul sensore

- Eliminare le fonti del riflesso
- Variare la distanza di rilevamento

1

Esce acqua tra leva e corpo

- Cartuccia rotta

- Sostituire la cartuccia

Esce solo acqua calda o fredda

Elettrovalvola bloccata

Richiedere ☎

Flusso di uscita ridotto

- Pressione alimentazione non sufficiente
- Cartuccia bloccata o sporca
- Uscita otturata per sporcizia o residuo calcare
- Filtri di ingresso ostruiti da sporcizia o calcare

- Controllare pressione
- Sostituire cartuccia
- Smontare e pulire aeratore
- Smontare e pulire i filtri

Regolazione di temperatura non adeguata

- Cartuccia bloccata o sporca
- Temperatura dell'acqua calda insufficiente

- Sostituire la cartuccia
- Verificare impianto

L'acqua in uscita è solo calda o solo fredda al contrario del movimento della leva

Ingressi acqua invertiti

Invertire gli ingressi acqua



DAMAGE

CAUSES

SOLUTIONS

1 2

No flow of water from tap

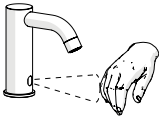

Exhausted battery (the led blinks)

Replace the battery

Electrical problem

- Disconnect and reconnect the battery
- Check the connections and the cable's integrity
- Damaged sensor: ask for

Filter is dirty

Clean the sensor window

Blocked solenoid valve

Ask for

The water flows for 1 minute (without any object in front of sensor) finally stop



Dirty sensor

Clean the sensor window

Light reflections on the sensor

- Remove the reflection sources
- Adjust the servey distance

Electrical problem

Disconnect and reconnect the battery (RESET)

The water remains open over 1 min

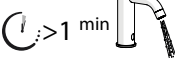

Blocked solenoid valve / damage sensor

Ask for

The faucet opens / closes independently with no reason

It's been 24 hours since the last one supply

Correct operation

Light reflections on the sensor

- Remove the reflection sources
- Adjust the servey distance

1

Water between handle and body

- Cartridge blocked

- Replace cartridge

It flows only hot or cold water

Blocked solenoid valve

Ask for

Out-let flow reduced

- Insufficient working pressure
- Cartridge blocked or dirty
- Outlet obstructed by dirt or limestone
- Filters in-lets obstructed by dirt and limestone

- Pressure check
- Replace cartridge
- Disassemble and clean aerator
- Disassemble and clean filtrs

Non-appropriate temperature regulation

- Cartridge blocked or dirty
- Hot water temperature insufficient









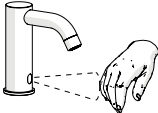

- Replace cartridge
- Check the system

Only hot or cold water flows, regardless of the handle selected

Water in-lets inverted

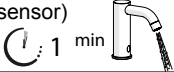
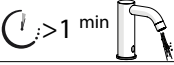
Invert water in-lets



FALLOS 	CAUSAS 	SOLUCIONES 
<p>1 2</p> <p>No se suministra agua</p> 	 <p>Batería descargada (el led r elampaguea continuamente)</p> <p>Problema eléctrico</p> <p>Los filtros están atascados</p> <p>Electroválvula bloqueada</p>	 <p>Reemplazar la batería</p> <p>- Desconectar y volver a conectar la batería - Verificar la conexión de los conectores y la integridad del cable - Sensor dañado: pedir </p> <p>Limpiar el sensor</p> <p>Pedir </p>
<p>El agua sigue flyendo durante 1 minuto (sin objetos delante del sensor)</p> 	<p>Sensor lucio</p> <p>Reflejos de luz sobre el sensor</p> <p>Problema eléctrico</p>	<p>Limpiar el sensor</p> <p>- Reflejos de luz sobre el sensor - Regular la distancia de estudio</p> <p>Desconectar y volver a conctar la batería (RESET)</p>
<p>El agua sigue fluyendo durante más que</p> 	<p>Electroválvula bloqueada / sensor dañado</p>	<p>Pedir </p>
<p>El grifo se abre/cierra sin razón</p>	<p>Han pasado 24 horas desde la ultima descarga</p> <p>Reflejos de luz sobre el sensor</p>	<p>Funcionamiento correcto </p> <p>- Reflejos de luz sobre el sensor - Regular la distancia de estudio</p>
<p>1</p> <p>El agua fluye entre el asa y el cuerpo.</p>	<p>- Cartucho bloqueado</p>	<p>- Vuelva a colocar el cartucho</p>
<p>Sólo sale el agua caliente o fría</p>	<p>Electroválvula bloqueada</p>	<p>Pedir </p>
<p>Caudal insuficiente</p>	<p>- Presión de alimentación insuficiente - Cartucho bloqueados o sucio - Salida bloqueada por cal o suciedad - Los filtros son obstruidos por la suciedad y la cal</p>	<p>- Revisión de la presión - Cambie el cartucho - Retire y limpie los aireador - Retire y limpie los filtros</p>
<p>Regulación temperatura incoprecta</p>	<p>- Cartucho bloqueados o sucio - Temperatura del agua caliente insuficiente</p>	<p>- Cambie el cartucho - Comprobar sistema</p>
<p>El agua saliente está sola. caliente o simplemente frío al contrario a la movimiento de la perilla</p>	<p>Entradas de agua invertidas</p>	<p>Invertir las entradas de aguas</p>



PROBLÈME

CAUSE

SOLUTION

1 2

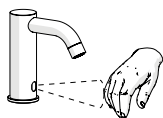
L'eau ne sort pas



Batterie épuisée (le led clignote)

Remplacer la batterie

Problème électrique

- Débrancher et re brancher la batterie
- Vérifier la connexion des connecteurs et l'intégrité du câble
- Capteur endommagé : demander ☎

Le filtre est obstrué

Nettoyer le filtre

Électrovanne bloqué

Demander ☎

L'eau reste ouverte pour 1 minute (sans objets en face au capteur)

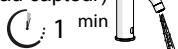

Capteur sale

Nettoyer le capteur

Reflets de lumière devant le capteur

- Éliminer les sources de lumière;
- régler la distance de enquête

Problème électrique

Débrancher et re brancher la batterie (RESET)

L'eau reste ouvert plus d'1 minute

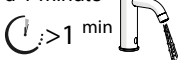

Électrovanne bloqué / capteur endommagé

Demander ☎

Le robinet s'ouvre/ferme sans raison

Elles sont passées plus de 24 heures de la dernier écoulement.

Fonctionnement correcte. ✓

Reflets de lumière devant le capteur

- Éliminer les sources de lumière;
- régler la distance de enquête

1

L'eau sort du manche et du corps

Seule l'eau sort chaud ou froid

- Cartouche cassée

- Remplacer la cartouche

Électrovanne bloqué

Demander ☎

Débit de sortie réduit

- Pression d'alimentation non assez
- Cartouche bloquée ou sale
- sortie obstruée pour la saleté ou résidus de calcaire
- Filtres d'entrée obstrués par la saleté ou calcaire

- Vérifier la pression
- Remplacez la cartouche
- Retirer et nettoyer l'aérateur
- Retirer et nettoyer les filtres

Ajustement de température pas adéquat

- Cartouche bloquée ou sale
- Température de l'eau chaude insuffisant

- Remplacez la cartouche
- Vérifier le système

L'eau sortante est seule chaud ou juste froid alcontrairement à lamouvement du bouton

Inversion des entrées d'eau

Inverser les entrées d'eau



GARANZIA / WARRANTY / GARANTÍA / GARANTIE



La garanzia non copre danni causati da :

- Deterioramento delle superfici cromate dovute all'uso di prodotti per la pulizia contenenti acidi o sostanze abrasive
- errori di installazione
- cattiva manutenzione
- atti vandalici
- sedimenti e aggressioni chimiche provocate da sostanze disciolte nell'acqua di alimentazione (ad. es: calcare, corpi estranei, acidi, prodotti di disinfezione, ecc.).



The warranty does not cover damages caused by:

- Deterioration of the chrome surfaces due to the use of cleaning products containing acids or abrasive substances
- incorrect installation
- negligence maintenance and use
- acts of vandalism
- contact with abrasive or corrosive chemicals caused the presence of any dissolved compound in the supply water (limestone, strange compounds, acids, ect.) .



La garantía no cubre desperfectos ocasionados por:

- Deterioro de las superficies cromadas por el uso de productos de limpieza que contienen ácidos o sustancias abrasivas
- errores de instalación
- negligencias en el mantenimiento
- actos vandálicos
- agresiones químicas causadas por sustancias mezcladas en el agua de alimentación (porej. Calizo, cuerpos extraños, ácidos, productos de desinfección).









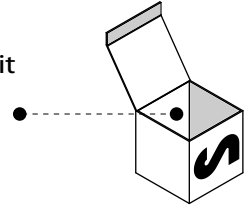

La garantie ne couvrir dommages causés par :

- Détérioration des surfaces chromées due à l'utilisation de produits de nettoyage contenant des acides ou des substances abrasives
- erreur d'installation
- mauvais entretien
- actes de vandalisme
- produits chimiques abrasifs ou corrosifs aussi la présence de substances présentes dans l'eau (comme calcaire, acides)

PARTI DI RICAMBIO CONSULTARE IL SITO
 SPARE PARTS CONSULT THE SITE
 PIEZAS DE RECAMBIO CONSULTE EL SITIO
 PIECES DE RECHANGE CONSULTER LE SITE

www.nobili.it



	<p>  Non smaltire insieme ai rifiuti indifferenziati, ma raccogliere separatamente. Smaltire e riciclare correttamente i RAEE significa ridurre i rischi per l'ambiente e per la salute umana. Per ulteriori informazioni rivolgersi al proprio rivenditore.</p> <p>  Do not dispose of with unsorted waste but collect separately. Proper disposal and recycling of WEEE means reducing risks to the environment and to human health. For further information contact your dealer.</p> <p>  No lo deseches con los residuos no clasificados, sino que los recoja por separado. Desechar y reciclar los RAEE correctamente significa reducir los riesgos para el medio ambiente y para la salud humana. Para más información contacte a su distribuidor.</p> <p>  Ne pas jeter avec les déchets non triés, mais les collecter séparément. Eliminer et recycler correctement les DEEE signifie réduire les risques pour l'environnement et pour la santé humaine. Pour plus d'informations, contactez votre revendeur.</p>

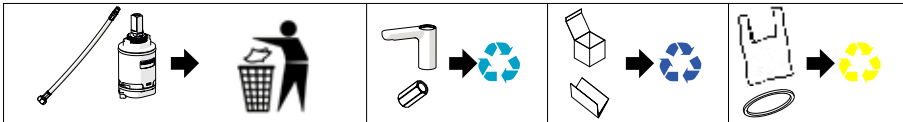

IISTRINFRA#---STD



REV3.04/2021