

-50%

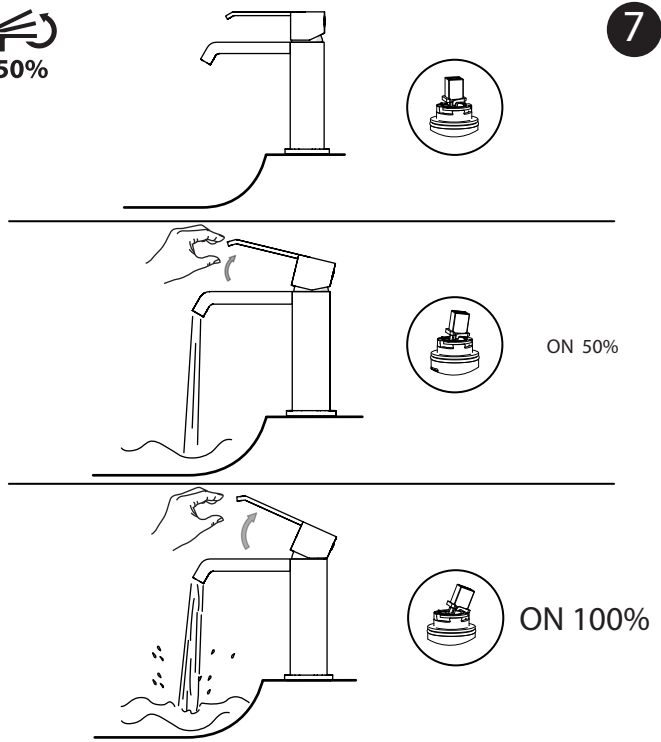

7

ON 50%

ON 100%



Per limitare la temperatura estrarre il limitatore e riposizionarlo nella posizione che si desidera

Extract the limiter and put it in correct position to limit temperature

9

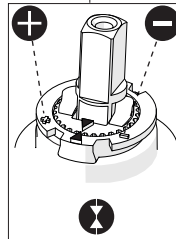
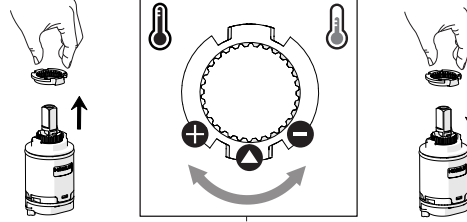

Nessuna limitazione di temperatura  
No limitation of temperature

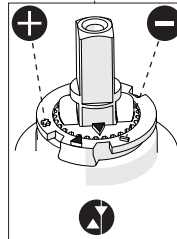

Limitazione parziale di temperatura  
Partial limitation of temperature

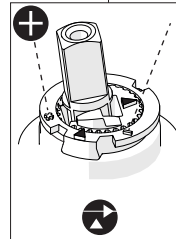

Massima limitazione Solo acqua fredda  
Maximum position Only cold water

**NOBILIS**<sup>®</sup>  
The Best Technology for Water



SF00118/1	SF00118/2
RY00118/1	RY00118/2
MI102118/1	MI102118/2
SL00118/1	SL00118/2

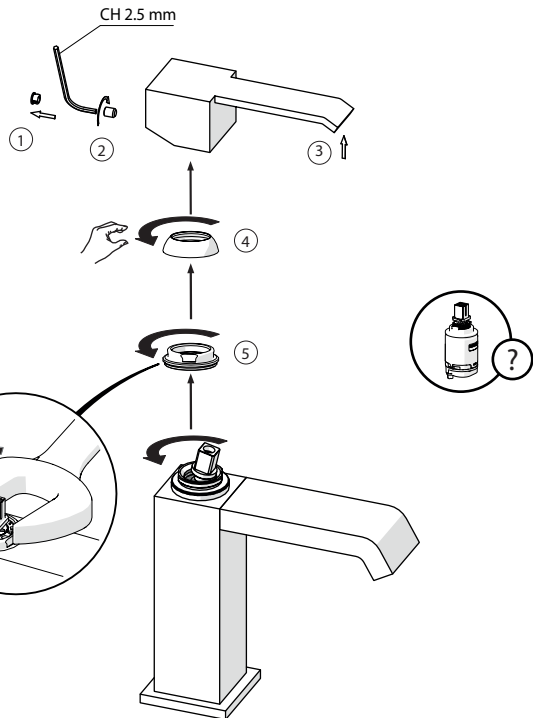
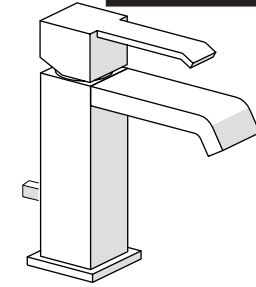

8

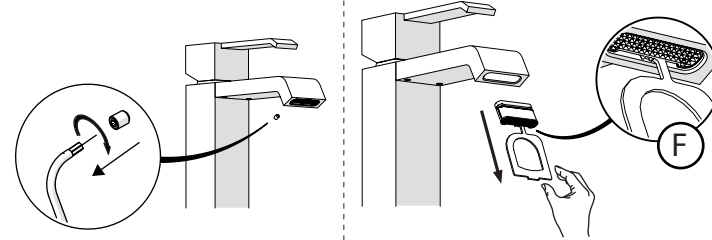

10

SF00118/1

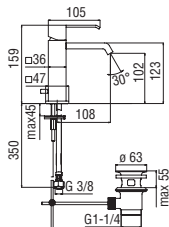

RY00118/1

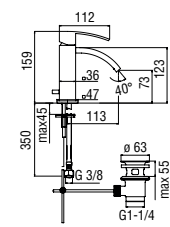

MI102118/1

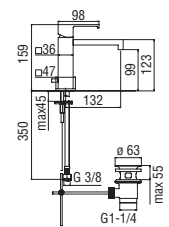

www.grupponobili.it

PRIMA DI INIZIARE / BEFORE STARTING

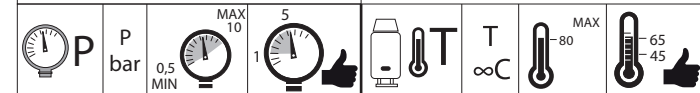

PULIZIA / CLEANING

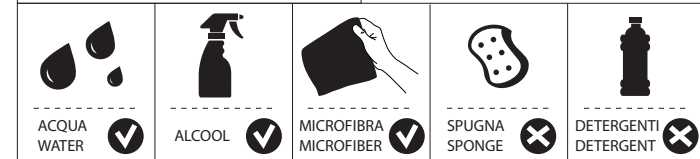

IISTRSF00118/1#---STD



REV2.07/2014

