



SPECIFICATIONS

Built-in 1-way single control mixer

Chrome

ø 1/2" hot and cold water inlet

ø 1/2" outlet

External part and flush-fit part

50% two step cartridge for water saving

Packaging: 14 x 12,5 x 8 cm / 0,0014 m³ / 0,85 kg

CERTIFICATIONS



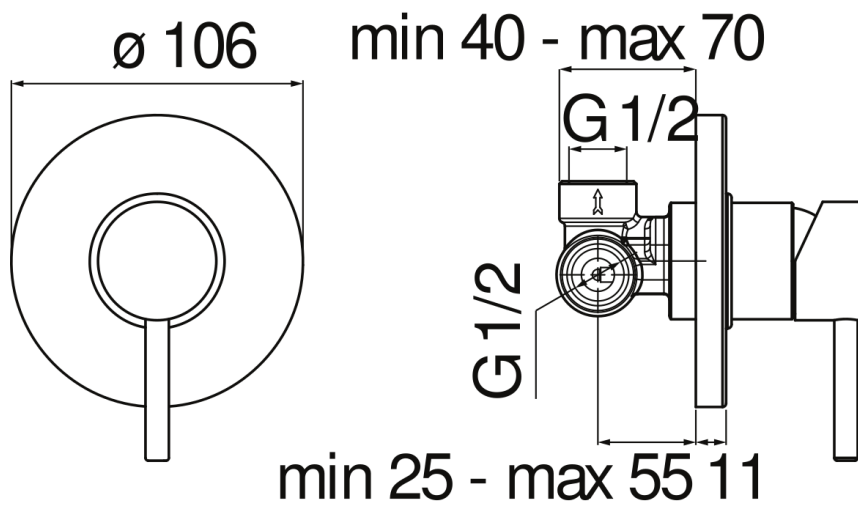

FLOW RATE DIAGRAM: HOT/COLD WATER

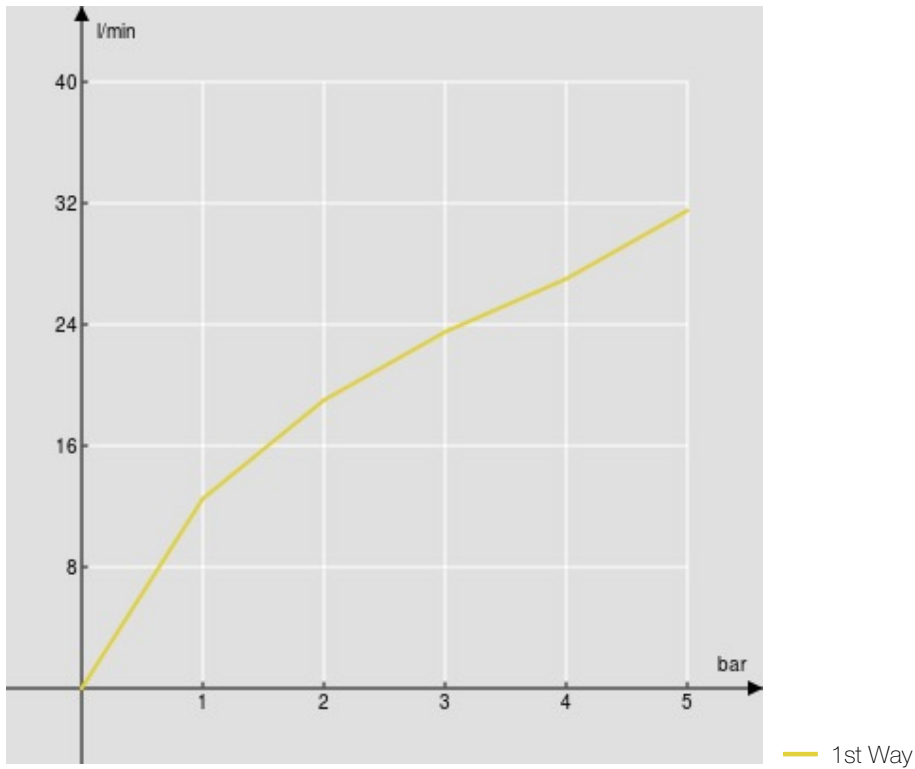

FLOW RATE DIAGRAM: MIXED WATER

