



SPECIFICATIONS

Wall-mounted single control external part long spout

Chrome

Anti limescale aerator M 22 x 1

Length of spout 200 mm

Without waste

50% two step cartridge for water saving

Packaging: 41 x 21 x 7 cm / 0,00603 m³ / 2,02 kg

CERTIFICATIONS



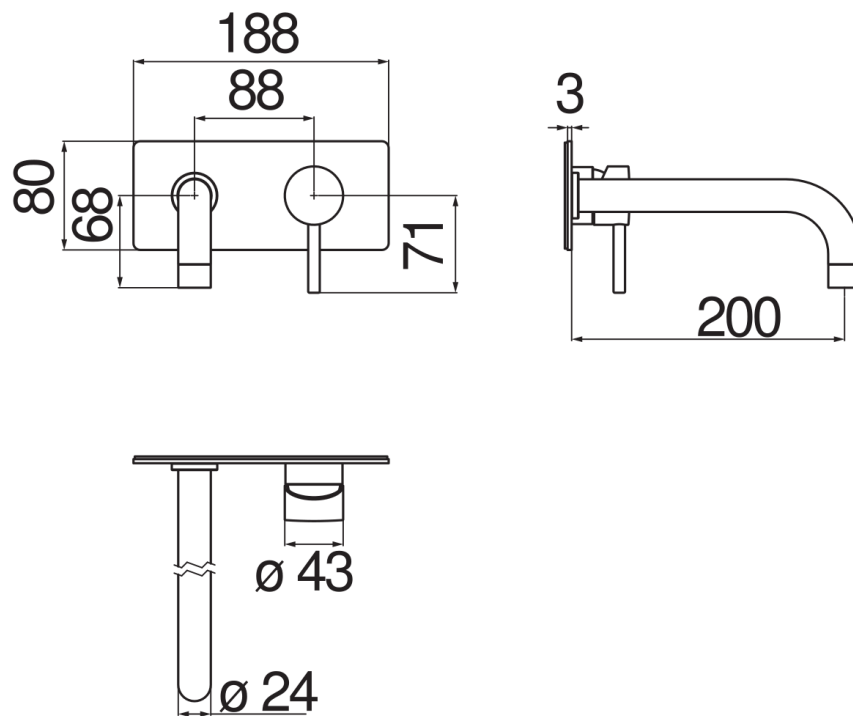

FLOW RATE DIAGRAM: HOT/COLD WATER



— Aerator

FLOW RATE DIAGRAM: MIXED WATER

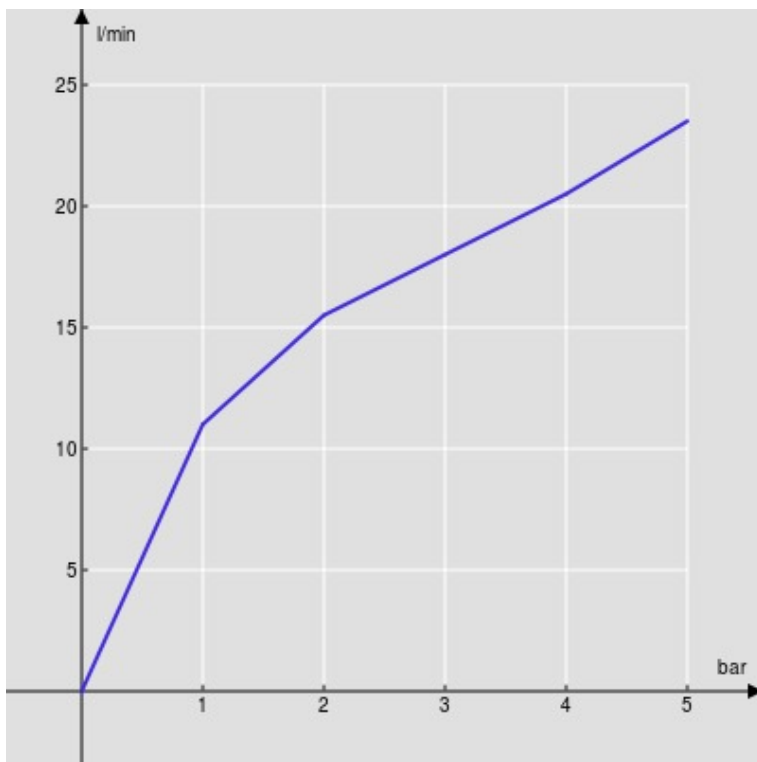

— Aerator