

SPECIFICATIONS

Wall-mounted single control external part

Chrome

Anti limescale aerator M 18 x 1

Length of spout 150 mm

Without waste

50% two step cartridge for water saving

Packaging: 32 x 16,5 x 7 cm / 0,0037 m³ / 1,9 kg

CERTIFICATIONS



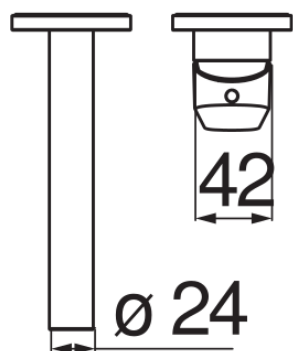
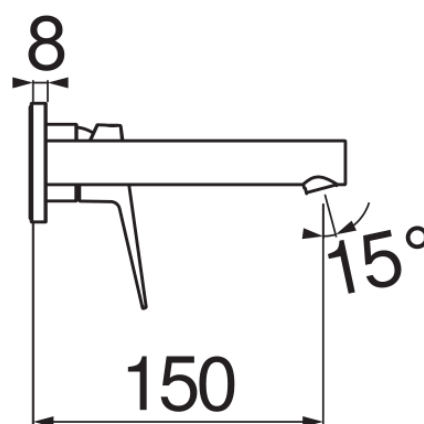
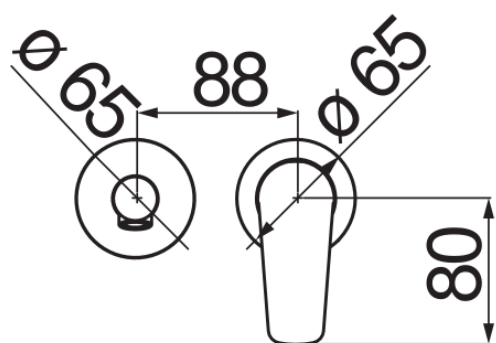

FLOW RATE DIAGRAM: HOT/COLD WATER

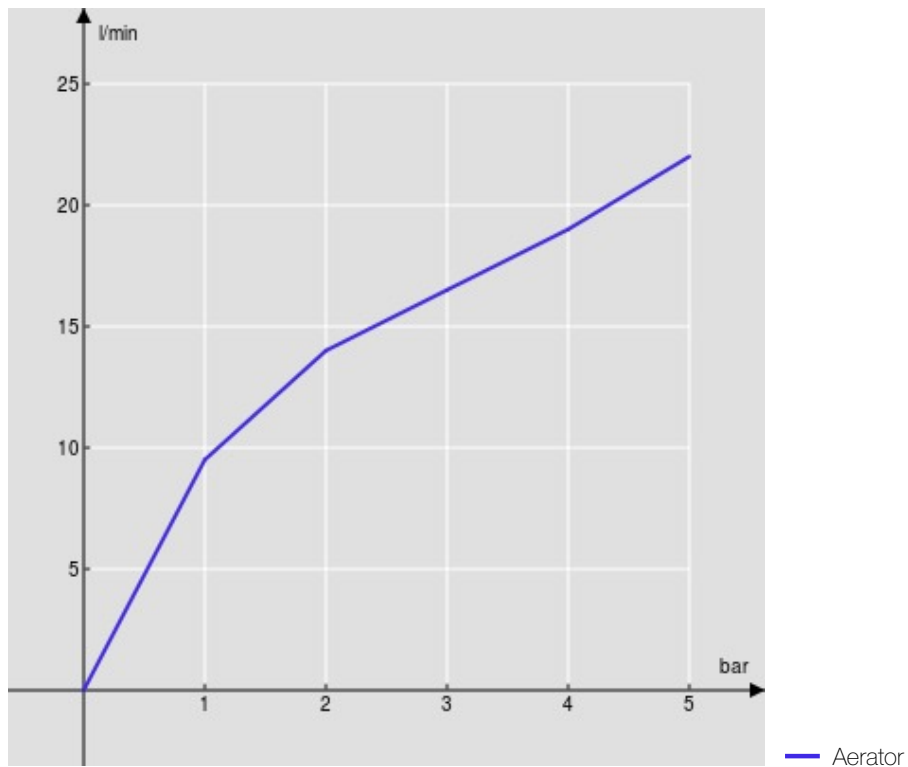

FLOW RATE DIAGRAM: MIXED WATER

